

FILE COPY

UNION SPECIAL

Industrial Sewing Machines

Instructions
for
Adjusting *and* Repairing
with
List of Parts

Styles

13200 A
15800 A
15800 B

15800 D
15800 E
15800 G

15900 A
15900 D
15900 E

CATALOG
No. 51 B

Second Edition

UNION SPECIAL MACHINE COMPANY
CHICAGO

CATALOG NO. 51 B

Second Edition

Instructions for ADJUSTING AND REPAIRING

Styles

13200 A	15800 D	15900 A
15800 A	15800 E	15900 D
15800 B	15800 G	15900 E

With List of Parts

UNION SPECIAL MACHINE COMPANY

Main Office and Factory: 400 North Franklin Street
CHICAGO, U. S. A.

BRANCHES AND SERVICE STATIONS, UNITED STATES

Boston, Mass. 210 Lincoln St. Tel. Liberty 0148	Philadelphia, Pa. 401 N. Broad St. Tel. Bell-Walnut 3131 Key-Race 1078	St. Louis, Mo. 1127 Pine St. Tel. Main 1776
New York, N. Y. 65-69 Bleecker St. Tel. Spring 7-8888	Cincinnati, Ohio 422-425 Temple Bar Bldg. Tel. Parkway 2521	Kansas City, Mo. 5014 College Ave. Tel. Wabash 6966
Johnson City, N. Y. 49 Cherry St. Tel. 7-3179 and 7-5423	Cleveland, Ohio 1276 W. 3rd St. Tel. Main 9657	Los Angeles, Calif. 307 F. W. Braun Building 1240 So. Main St. Prospect 5636
Waterford, N. Y. 22 4th St. Tel. 467	Atlanta, Ga. 155 Spring St. Tel. Main 3377	San Francisco, Calif. 682 Mission St. Tel. Garfield 7999

SERVICE REPRESENTATIVES, UNITED STATES

Baltimore, Md. 17 Guilford Ave. Tel. Plaza 4262	Detroit, Mich. 2725 Boston Blvd., W. Tel. Euclid 4118	Ft. Worth, Texas 912 Morningside Drive Tel. 4-7776
Newark, N. J. 60 Park Place Tel. Mulberry 4-3123	Nashville, Tenn. 203 Golf Club Lane Tel. 7-7937-J	Seattle, Washington 2128 Westlake Ave. Tel. Eliot 0144
Greensboro, N. C. 108 So. Aycock St. Tel. 6301	Minneapolis, Minn. 3608 27th Ave., South Tel. Drexel 3331	York, Pa. 49 N. George St. Tel. 2886

BRANCHES—FOREIGN

Union Special Machine Corporation of America.	Belgium, Brussels
Union Special Machine Company of Canada, Ltd.	Canada, Toronto
Union Special Machine Company of Canada, Ltd.	Canada, Montreal
Union Special Machine Corporation of America.	Denmark, Copenhagen
Union Special Machine Company, Ltd.	England, Leicester
Union Special Machine Company, Ltd.	England, London
Union Special Machine Company, Ltd.	England, Manchester
Compagnie des Machines Union Special de France.	France, Paris
Compagnie des Machines Union Special de France.	France, Lyons

UNION SPECIAL MASCHINENFABRIK, G. m. b. H.

General Office and Factory: STUTTGART, GERMANY

BRANCHES AND SERVICE STATIONS, GERMANY

Berlin	Köln	Frankfurt am Main
Chemnitz	Ebingen	

Foreign Distributors and Service Stations Are Found in:

Argentina Republic Buenos Aires	China Hong Kong Shanghai Tientsin	Japan Osaka Tokyo	Norway Oslo	South Africa Johannesburg
Austria Vienna	Cuba Havana	Mauritius Port Louis	Philippine Islands Manila	Durban Capetown Port Elizabeth
Australia Brisbane Melbourne Perth Sydney	Finland Tammerfors	Mexico Mexico City Monterrey	Peru Lima	Spain Barcelona
Brazil Sao Paulo Pernambuco	Hawaiian Islands Honolulu	Netherlands Amsterdam	Portugal Oporto	Sweden Boras Stockholm
British West Indies Kingston	India Bombay Calcutta	New Zealand Auckland Christchurch Wellington Dunedin	Puerto Rico San Juan	Switzerland Zurich
Chile Santiago	Italy Milan		Scotland Glasgow Dundee	Uruguay Montevideo

Copyright, 1925, by Union Special Machine Co.

CONTENTS

	Page
Application of Catalog.....	3
Identification of Machines.....	4
Adjusting	6
Formation of the Double Locked Stitch.....	6
Tensions	12
Regulating Length of Stitch.....	14
Setting Binding Attachment.....	14
Trimming Mechanism.....	15
Setting the Knives.....	16
Changing Width of Seam.....	16
Knife Grinder.....	18
Grinding the Knives.....	18
Repairing	21
Assembling	22
Needles	24
Ordering Repair Parts.....	25
Plates	26
List of Parts.....	56

PROPERTY OF
DEVELOPMENT/CATALOG DEPT.

Please return to the Catalog Dept.

Date received to file: DEC 08 1992

APPLICATION OF CATALOG

This catalog applies only to the styles of machines with gauges and widths of binding as specified below.

Styles	Gauges	Widths of Binding
13200 A	2	$\frac{3}{4}$, $\frac{7}{8}$, 1, $1\frac{1}{8}$
13200 A	4	$\frac{3}{4}$, $\frac{7}{8}$, 1, $1\frac{1}{8}$
15800 A		$\frac{3}{4}$, $\frac{7}{8}$, 1, $1\frac{1}{8}$
15800 B		$\frac{3}{4}$, $\frac{7}{8}$, 1
15800 D		
15800 E		
15800 G		
15900 A		
15900 D		$\frac{3}{4}$, $\frac{7}{8}$, 1, $1\frac{1}{4}$
15900 E		

It can be applied with discretion to other styles.

Instructions for installing and operating these machines, together with illustrations of oiling and threading diagrams, are found in Catalog No. 51 A. Information relative to the transmitter is contained in Catalog No. 29. Needles are listed and fully described in Catalog No. 45. These catalogs will be furnished gratis on request.

IDENTIFICATION OF MACHINES

A machine equipped with specified parts and fitted for a specific operation is given a **STYLE NUMBER**, the symbol for which is a number evenly divisible by 100, with a letter affixed. Example: 13200 A, 15800 D, 15900 D.

Styles of machines, similar in construction, are grouped and given a **CLASS NUMBER**, the symbol for which is a number evenly divisible by 100, without a letter affixed. Example: 13200, 15800, 15900.

Attached to each machine will be found a name plate, stamped with either the style number or the class number.

The measurement of the space between the rows of stitching made by styles in Class 13200 is represented by a gauge number. The spacing of the gauges is as follows: 2 gauge, $\frac{1}{8}$ inch; 4 gauge, $\frac{3}{16}$ inch.

STYLES OF MACHINES IN CLASS 13200

Flat Bed, Two Needles, Two Loopers, Right Hand Needle In Front,
With Trimmer, Low Bed, 10 Inches Long, Needle
Lever Connection Under Arm.

13200 A For seaming and binding, in one operation, dresses, crash clothing, bathrobes, and similar garments made from fabrics which fray readily, spring-pressed knife engagement trimming mechanism, double locked stitch, floor treadle lifter, Type 106 needles.

13200 Z A special style similar to the standard styles in Class 13200, but not specifically defined. It is always fitted with one or more parts differing from the fitting of any of the standard styles in the class, and is often fitted for a different operation.

STYLES OF MACHINES IN CLASS 15800

Flat Bed, One Needle, With Trimmer, Low Bed, 10 Inches Long,
Needle Lever Connection Under Arm.

15800 A For seaming and binding dresses, shirt waists, and similar garments, spring-pressed knife engagement trimming mechanism, double locked stitch, floor treadle lifter, Type 106 needles.

15800 B For binding coats, bathrobes, mackinaws, and similar garments, spring-pressed knife engagement trimming mechanism, double locked stitch, tandem differential feed, floor treadle lifter, Type 106 needles.

IDENTIFICATION OF MACHINES

- 15800 D For seaming sweaters and heavy-weight knitted materials, fixed knife engagement trimming mechanism, double locked stitch, tandem differential feed, minimum width of seam $\frac{1}{8}$ inch, floor treadle lifter, Type 121 needles.
- 15800 E For closing toes of heavy-weight stockings, seaming light weight knit underwear and other light-weight material, fixed knife engagement trimming mechanism, double locked stitch, tandem differential feed, minimum width of seam $\frac{1}{16}$ inch, floor treadle lifter, Type 121 needles.
- 15800 G For seaming fleece lined underwear and other medium-weight knitted garments, fixed knife engagement trimming mechanism, double locked stitch, minimum width of seam $\frac{1}{8}$ inch, floor treadle lifter, Type 121 needles.
- 15800 Z A special style similar to the standard styles in Class 15800 but not specifically defined. It is always fitted with one or more parts differing from the fitting of any of the standard styles in the class, and is often fitted for a different operation.

STYLES OF MACHINES IN CLASS 15900

Flat Bed, One Needle, Low Bed, 10 Inches Long, Needle Lever Connection Under Arm.

- 15900 A For seaming seat and inseam of trousers, seaming coats and similar garments, double locked stitch, floor treadle lifter, Type 128 needle.
- 15900 D For binding aprons, dresses and similar garments, double locked stitch, floor treadle lifter, Type 106 needle.
- 15900 E For stitching rick-rack braid to dresses, aprons and similar garments, folder for edge of body fabric and adjustable guide for braid, double locked stitch, floor treadle lifter, Type 106 needle.
- 15900 Z A special style, similar to the standard styles in Class 15900, but not specifically defined. It is always fitted with one or more parts differing from the fitting of any of the standard styles in the class, and is often fitted for a different operation.

ADJUSTING

GENERAL PLAN The steps necessary to readjust the machine or check its adjustment are given in the order most convenient for the machine fixer to follow.

The styles in Class 13200 use two needles and two loopers which make them slightly different from styles in Classes 15800 and 15900, which use only one needle and one looper. The instructions given apply directly to styles in Classes 15800 and 15900. Their application to styles in Class 13200 is a simple matter as the mechanism is practically the same. Where it differs, specific adjusting information is furnished.

In describing the positions or movements of the parts, there is but one point of view used. It is that of the operator sitting in front of the machine.

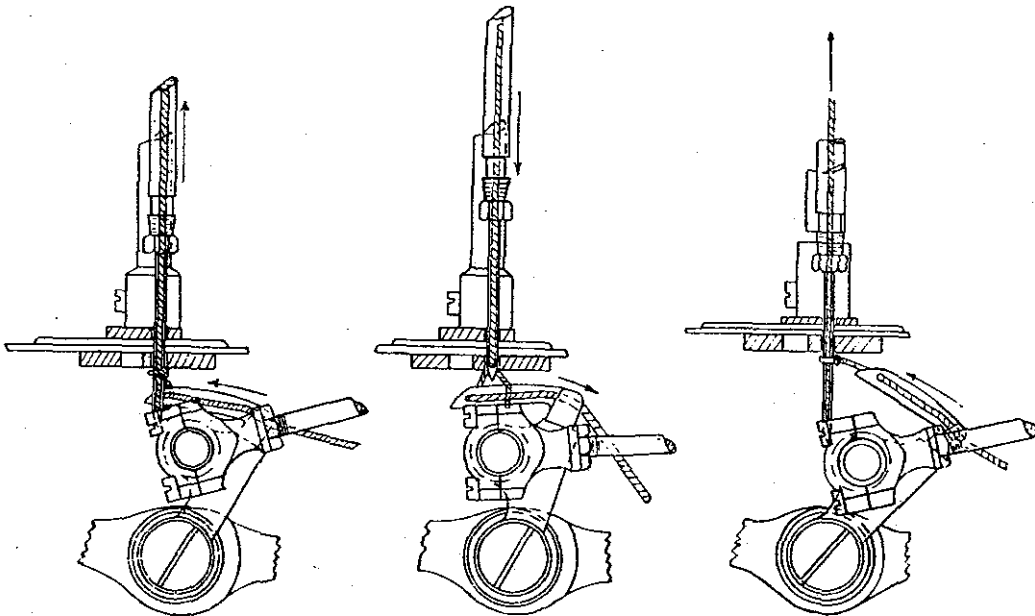

FIGURE 1

FIGURE 2

FIGURE 3

FORMATION OF THE The accompanying illustrations “**DOUBLE LOCKED STITCH**” show the three steps in the formation of the “double locked stitch.” A careful study of them and the explanatory matter will be of considerable assistance in making an adjustment. Frequent references to these illustrations are made.

The needle carries its thread down through the fabric and, as it ascends, throws out a loop at the rear, which the looper enters as

ADJUSTING

shown in Fig. 1. While the needle is above the throat plate, the feed dog moves the fabric to the rear, the looper rocks to the front across the path of the needle and returns to the right, forming a triangular space—bounded by the back of the looper, the looper thread on the left and the needle thread on the right—into which the needle descends with its thread, as shown in Fig. 2. The looper, continuing to return to the right, leaves the stitch on the needle, as shown in Fig. 3. The needle, again ascending, recedes from the stitch, which is tightened in the fabric by the action of the looper as it forms the next stitch.

The tension applied to the needle thread controls the tightness of the stitches.

CAUTION When a machine fails to work satisfactorily, though apparently in good repair, it is possible that some minor trouble exists. For this reason, delay may be avoided by acting on the following suggestions:

- (1) Check the machine according to operating instructions under the subject "Useful Hints" in Catalog No. 51 A.
- (2) See that the needle thread tensions are as tight as is consistent with the strength of the thread. See that the looper thread tensions are quite loose. The looper threads require only a slight tension, barely enough to steady them in passing through the machine.
- (3) The throat plate needle hole, thread eyelet, tension discs, and needle thread take-up may have become roughened or grooved, which will cause breaking of both the needle and looper threads. It can be remedied by smoothing the surfaces with emery cloth.
- (4) Unravel the stitching and note if the threads are cut or injured. The teeth of the feed dog may be cutting the stitch on the under surface of the fabric.
- (5) Before operating by power, after any change has been made in the working parts, always turn the machine by hand, to be sure that it runs freely and that the working parts do not interfere with the frame or with each other.

If the foregoing suggestions fail, the adjustment should be checked with the following instructions. While many variations can be made, the best results will be secured by following them.

ACCESSIBILITY To secure an unobstructed view of the looper, remove the cloth plate and looper needle guard.

Note: In adjusting machines, always use a new needle.

NEEDLE REAR GUARD This forces the needle into proper position, should it glance toward the rear of the machine in passing

ADJUSTING

through the fabric. Three types are used in the machines covered by this catalog.

Styles 15900 A, 15900 D, and 15900 E are equipped with a stationary type. It is fastened in a seat milled in the under side of the throat plate. A slight variation in its position can be secured by slightly loosening the screw and forcing the guard in the desired direction while the screw is retightened. It is set correctly when its vertical face barely touches the rear of the needle.

Styles 15800 D, 15800 E and 15800 G are also equipped with a stationary type, adjustably secured to the lower knife support. It is set correctly when its vertical face barely touches the rear of the needle.

Styles in Class 13200, Styles 15800 A and 15800 B are equipped with a moving type secured to the feed bar. It is set correctly when its vertical face or faces barely touch the rear of the needle when the guard is at its extreme forward position.

As it moves with the feed dog, the guard must be readjusted each time the length of the stitch is altered.

The needle bar in styles in Class 13200 should be turned in its bearings so that the oblique position of the needles corresponds with the oblique position of the two vertical faces of the needle rear guard.

LOOPER COLLARS These are placed over the shanks of loopers in Styles 13200 A, 15900 D, and 15900 E. They are furnished in three thicknesses. No. 21210 is .040 inch thick, No. 21210 A is .020 inch thick, and No. 21211 is .054 inch thick. Additional variations can be secured by driving the collar into the end of a wooden block and reducing its thickness with a file. The collars used should be of sufficient thickness so that when the loopers are seated in the looper rocker, the smallest space between the top of the loopers and underside of throat plate, when the loopers are in their highest position, is just enough to pass a double thickness of newspaper.

NEEDLE AND LOOPER Three adjustments are necessary to bring these in proper time.

FIRST ADJUSTMENT The space between the center of the needle and point of the looper, when the needle is at its lowest position, should be $7/32$ inch. This space controls the size and form of needle loop. A very convenient manner of securing an accurate adjustment will be found by using a looper adjusting gauge No. 21225- $7/32$, having a "V" slot, the center of which is $7/32$ inch from the edge of the wider side, as indicated by the dotted line in the cut. In using this gauge, hold it with the "V" slot enclosing

ADJUSTING

the front of the needle, with the wider side of the gauge to the right. Then, the needle being at its lowest position, the point of the looper should be made to come even with the right-hand edge of the gauge by turning the looper connecting rod, which is provided with right and left threads. To loosen nuts, use wrench No. 21388 and turn them to the rear. In tightening the looper connecting rod nuts, care should be taken to see that the left ball joint has side play in all positions. First tighten the left nut securely. Then, turn the pulley in the operative direction till the long straight edge of the looper thread take-up is in its front vertical position and tighten the right-hand nut securely. Again apply the gauge to make sure that the adjustment has not been altered.

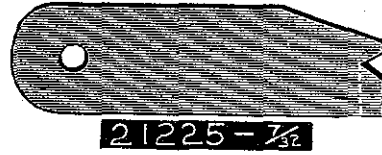

The front looper of styles in Class 13200 should likewise be set to the 7/32 inch gauge. With this adjustment of the front looper, the distance from the point of the back looper to the center of the back needle should be approximately the same. If the distance is greater, set the back looper to the looper gauge by turning the looper connecting rod.

SECOND ADJUSTMENT To set the needle at its proper height with respect to the looper, turn the machine pulley in its operative direction till the point of the looper, moving from right to left, is even with the left side of the needle. Then the measurement from the under side of the looper to the upper edge of the needle eye should be 1/64 inch for Styles 15800 A, 15900 D, and 15900 E; 1/32 inch for Style 15900 A; and 3/64 inch for Styles 13200 A, 15800 D, 15800 E and 15800 G. Enough variation is allowable to have the upper edge of the needle eye 1/64 inch lower than the foregoing measurements, without interfering with the functions of the loopers and needles, as shown in Figs. 1 and 2, respectively, of the stitch formation. The adjustment is made by moving the needle bar.

Care should be taken when adjusting styles in Class 13200 to avoid turning the needle bar in its bearings, as that will destroy the oblique adjustment of the needles. An excellent plan is as follows: Place the fingers of the left hand back of the presser guide bar bearings, and press the thumb firmly against the front of the needle bar. With the right hand, loosen the two needle bar set screws, and turn the pulley so that the needle bar connection will be moved upward if the needle bar is to be lowered; turn the pulley in the opposite direction if the needle bar is to be raised.

ADJUSTING

THIRD ADJUSTMENT When the looper moves to the left to enter the needle loop as shown in Fig. 1 of the stitch formation, there should be approximately .010 inch space between the looper point and the back of the needle. A space of .010 inch is easily visualized by cutting three plies of newspaper simultaneously with a pair of sharp scissors and bringing the cut edge into view by holding the paper together with both hands. A variation from .005 to .0156 (1/64 inch) is allowable. To adjust the position of the looper, turn the pulley till the looper point is directly behind the needle; loosen the two screws which hold the looper rock shaft frame to the bed; move the frame to the front till the looper point noticeably deflects the needle; tighten the screws slightly to force the frame into a level position; tap the frame backward to the desired position with the handle of a screw driver; retighten the frame screws securely.

A small piece of white paper placed to the left of the needle as a background will be found convenient in making this adjustment.

NEEDLE FRONT GUARD A guard is attached to the looper to force the needle into its proper position should it glance toward the front of the machine in passing through the fabric. The guard is set correctly when it barely passes the needle without striking it. The screw hole is elongated to permit this adjustment.

On styles in Class 13200, the foregoing applies only to the front looper.

LOOPER THREAD TAKE-UP AND CAST-OFF WIRE Near the middle of the main shaft is located a device for controlling the looper thread. It consists of a take-up, cast-off wire, and take-up thread eyelet. Their function is to hold the looper thread taut till the descending needle point has passed below the looper thread as shown in Fig. 2 of the stitch formation, and continue to hold the thread till the eye of the looper is to the left of the middle of the needle, then release it.

A simple test to determine whether they are in adjustment can be made as follows: Take hold of the looper thread on the left side of the thread eyelet, draw it slowly through the eyelet, and while so doing, turn the machine pulley in its operative direction, until the thread moves from the long straight edge of the take-up to the circular edge. Stop at this point. The needle point should be below the middle of the looper. Enough variation is allowable to have the point even with the lower edge of the looper.

The prongs of the take-up thread eyelet, which project over the main shaft, are set correctly when they just clear the main shaft

ADJUSTING

sleeves. To change the height of the prongs, loosen the lock nut on the stop screw and change the position of the stop screw in the take-up thread eyelet holder.

INTERMITTENT LOOPER Attached to the front side of the
THREAD NIPPER main shaft middle bearing is a pair
SPRINGS of nipper springs, which clamp the
looper thread when the looper is moving to the right. Their purpose is to prevent the take-up from drawing additional looper thread through the tension instead of holding taut the thread where it passes from the looper eye to the throat plate needle hole as shown in Fig. 2 of the stitch formation. They are set correctly when they begin to clamp the thread as soon as the looper has completed its movement to the left and returned about 1/64 inch. Their operation can readily be observed by threading the machine in the regular manner and drawing the thread, care being taken to leave some slack between the tension and the nipper springs. The adjustment is made by changing the position of the operating arm on the looper rock shaft.

NEEDLE BAR Fastened to the needle bar is a thread nipper.
THREAD NIPPER Its purpose is to counteract the elasticity of the needle thread and enable the needle to throw out steady loops. The slightest appreciable tension is all that is required. The adjustment is made by lengthening or shortening the spring.

FEED DOGS It is important that the feed dog be set at just the proper height above the throat plate. If the tips of the teeth do not rise high enough, imperfect feeding of the work will result. If they rise too high, imperfect feeding of the work will likewise result, because the teeth will remain in contact with the fabric after the motion of the feed dog has reversed. The feed dogs should be set so that the tips of their teeth will rise approximately 3/64 inch above the throat plate. Variations to insure proper feeding and consistent with the fabric are allowable. There are two types of feeding mechanism used in machines covered by this catalog, non-differential and differential.

NON-DIFFERENTIAL This consists of a single feed dog ad-
FEEDING MECHANISM justably secured to the feed bar. Its height is maintained by a supporting screw under the feed dog.

DIFFERENTIAL This consists of two feed dogs, a main
FEEDING MECHANISM feed dog and a differential feed dog. They are both adjustably secured to their respective feed bars. The differential feed bar is driven by a link, adjustably secured by a

ADJUSTING

stud to a slot in the feed rocker. When the stud is in its lowest position in the slot, the differential feed dog travels in unison with the main feed dog. The desired differential motion can be obtained by raising the stud. If the travel of the differential feed dog relative to the main feed dog is too long, it will gather or shorten the fabric at the seams. If its travel is too short, it will stretch or lengthen the fabric. Care should be taken to see that the feed dogs do not strike the ends of the throat plate slots.

PRESSURE On top of the machine near the middle will be found a thumb screw for regulating the pressure of the presser foot on the fabric. Only sufficient pressure is required to enable the machine to feed properly and to firmly hold the fabric while the needles are being withdrawn. Care should be taken to avoid tightening the screw to the extent that the spring rests on the machine bed because this condition will decrease the pressure.

TENSIONS The importance of properly adjusted tensions can scarcely be over-estimated. Not only the required tightness or looseness of the stitches, but their uniform appearance is dependent on this adjustment.

For stitching inelastic fabrics, the tension on the needle threads should be as tight as is consistent with their strength and avoid puckering the fabric. For stitching elastic fabric such as knitted goods, the tension on the needle threads should be considerably less to secure the desired elasticity in the stitches.

The tension on the looper threads should be very slight; only sufficient to steady them in passing through the machine.

THREAD For regular stitching, the needle thread should be two or three sizes larger than the looper thread. While a glaze or soft finish thread can be used in the needle, a soft finish is always preferable in the looper.

NEEDLE THREAD CONTROLLER While only one type of needle thread controller is used on each machine, two types are used on the machines covered by this catalog. The automatic type is used on machines in Classes 13200 and 15900 and the non automatic type on machines in Class 15800.

AUTOMATIC NEEDLE THREAD CONTROLLER On the upper part of the machine will be found a lever, connected with the presser bar. It carries a guide for the needle thread at its right-hand end, which co-operates with two eyelets fastened to the needle lever, one to the right and the other to the left.

ADJUSTING

Its purpose is to take up the slack in the needle thread while the looper is returning to the right. As it is connected with the presser bar, it automatically adjusts itself for any thickness of fabric; that is, when the presser foot ascends or descends, as thicker or thinner fabric passes under it, the thread controller guide moves in the opposite direction, and takes up a decreased amount of slack on the thicker fabric, or an increased amount on the thinner fabric.

The adjustment can only be made by threading the machine and running it on the fabric.

Where a tight seam is required, which necessitates a tension on the needle thread as tight as consistent with its strength, the thread controller guide should be set so that, when the needle is at its lowest position, there will be the smallest noticeable slack in the thread. If there is no slack the thread controller guide may have to be lowered, as the needle, moving at full speed, descends a trifle farther and the strain at the eye will cause frequent breaking of the thread. If there is more than 1/16 inch of slack, the guide may have to be raised; otherwise, the stitch around the needle will remain below the throat plate and will interfere with the formation of the needle loop, as the looper moves to the left in the formation of the new stitch.

Where a comparatively loose tension is required to avoid puckering the fabric, or for operations where the machine has to continue to make stitches, after the fabric has passed beyond the needle, the thread controller guide should be set a trifle higher.

The position of the guide is altered by moving the rack on the presser bar.

If any needle thread is drawn through the tension as the needle descends, it may be accurately observed while turning the pulley by hand.

To ascertain the amount of slack in the needle thread, turn the pulley till the needle passes down through the fabric to its lowest position, place the fingers on the thread a short distance above the needle clamp nut, and draw upward.

The thread controller guide should never be set so that it will descend lower than 1/32 inch below a straight line connecting the two eyelets on the needle lever, when the needle is at its highest position and the presser foot is bearing on the thickest part of the work, as its action would be interfered with.

NON-AUTOMATIC NEEDLE Its purpose is the same as the automatic type except that it is non-automatic in operation. It is usually set as high as its slot will permit.
THREAD CONTROLLER

ADJUSTING

REGULATING LENGTH OF STITCH This is accomplished at the left end of the main shaft. There, three screws in a row will be found with a lock nut to the left of them. The length of stitch is altered by loosening the nut and turning the stitch regulating screw which is the largest of the three. Turning it to the right lengthens the stitch, and turning to the left shortens it. To loosen nut, use screw driver wrench No. 21206 and turn it in the direction the machine runs. Apply the wrench with the left hand and hold the machine pulley with the right hand.

Always tighten the lock nut after any change has been made. Note the effect of turning the stitch regulating screw. If it is turned too far to the right, the feed dogs will strike the ends of the slots in the throat plate. If it is turned too far to the left, the machine will feed the work towards the operator.

Each time the length of stitch is altered on machines having a needle rear guard attached to the feed bar, the guard must be readjusted to compensate for the change.

SETTING BINDING ATTACHMENT It should be set as close to the needle as possible in order to maintain the sewing margin on both convex and concave edges. The attachment should also be set as low as possible so that the body fabric feeds through the middle of the delivering end. The sewing margin can be varied on either side of the binding by tilting the attachment. Tilting the delivering end of the attachment upwardly decreases the margin on the top of the binding and increases the margin on the bottom tilting the delivering end downwardly acts the reverse.

TRIMMING MECHANISM

DESCRIPTION While only one type of trimming mechanism is used on each machine, two types are used on machines covered by this catalog. Styles in Class 13200 and Styles 15800 A and 15800 B are fitted with the spring-pressed knife engagement type. Styles 15800 D, 15800 E, and 15800 G are fitted with the fixed knife engagement type.

SPRING-PRESSED KNIFE ENGAGEMENT TYPE The upper knife is spring-pressed against the lower knife, the pressure being regulated by means of the spring chamber, Catalog No. 15876. To increase the pressure, loosen the clamp screw on the spring chamber and move the chamber to the right. Tighten the clamp screw after each adjustment. Only sufficient pressure should be applied to enable the knives to cut properly, any additional pressure will necessitate sharpening at shorter intervals.

To accurately set the knife bar locking bolt, it is provided with a bushing having a right-hand internal and a left-hand external thread. To take up the wear, loosen the set screw and turn the bushing to the left.

On the right-hand end of the upper knife bar shaft will be found a locking lever, adjustably secured by a clamp screw. It should be set so that it will mesh with the upper knife bar shaft locking lever block when the upper knife bar is raised to its extreme non-operative position.

The left side of the upper knife must be square with the throat plate. The upper knife should be set so that it is deflected the smallest noticeable amount to the right as it passes the cutting edge of the lower knife. Should it be necessary to make either of these adjustments, lock the upper knife bar in operative position, apply a wrench to the front of the upper knife bar, force the upper knife to the right, and twist as required; care being taken not to break the guiding toe of the upper knife.

FIXED KNIFE ENGAGEMENT TYPE The upper knife is fixed laterally. It should be set so that it bears lightly against the lower knife. Only sufficient pressure should be applied to enable the knives to cut properly, any additional pressure will necessitate sharpening at shorter intervals.

The left side of the upper knife must be square with the throat plate. The upper knife should be set so that it is deflected the

TRIMMING MECHANISM

smallest noticeable amount to the right as it passes the cutting edge of the lower knife.

The upper knife bar locking lever is adjustably secured on the rock shaft by a clamp screw. The relative position of the lever on the shaft should be such as to permit the lowest part of the upper knife bar carrier, Catalog No. 15872 A, when in operation, to descend within $\frac{7}{8}$ inch of the top of the cloth plate cover.

SETTING THE KNIVES Instructions relative to setting the knives are given under that subject in Catalog No. 51 A.

CHANGING THE KNIVES There is no economy in putting in only one resharpened knife because a new cutting edge, operating with an old one, will become dull after a comparatively short service. The small amount of grinding required when they are only slightly dulled more than compensates for the labor of changing them.

Resharpened knives should be put in at regular intervals without regard to the service the old ones have performed. Unsatisfactory work due to the operator's failure to notice that the knives are not cutting properly will be avoided. The interval will necessarily depend on the class of goods being cut, and on the lateral pressure of the upper knife against the lower one. In many factories, operators are given a few sets of knives and they make the change at regular intervals.

CHANGING WIDTH OF SEAM On machines fitted with a trimming mechanism, the width of seam is changed by laterally moving the lower knife support.

On machines fitted with the spring-pressed knife engagement trimming mechanism, loosen the clamp screw at the front of the cloth plate and turn the adjusting screw at the left end of the cloth plate. Turning the adjusting screw to the right decreases the width of seam, and turning it to the left acts the reverse. Tighten the clamp screw after the adjustment has been made. In decreasing the width of seam, care should be taken to see that the lower knife is not sprung by being drawn against the throat plate. In increasing the width of seam, raise the upper knife out of operative position to prevent the guiding toe from being broken. The upper knife and front cover diverting guide being spring-pressed against the lower knife, automatically adjust themselves with each change in the width of seam.

On machines fitted with the fixed knife engagement trimming mechanism, remove the cloth plate, loosen the screws which hold the lower knife support to the bed, and turn the adjusting screw at the

TRIMMING MECHANISM

left end of the machine. Turning the adjusting screw to the right decreases the width of seam, and turning it to the left acts the reverse. Tighten the lower knife support screws after the adjustment has been made. Reset the upper knife. The widths of seam that can be obtained from the various combinations of throat plates and lower knives, when the lower knife is tight against the throat plate, which is its most favorable location, are as follows:

Style of Machine	Throat Plate	Knife	Width of Seam
15800 D	15824 D	15849 D	1/8 inch
	15824 D	15849 E	11/64 inch
	15824 H	15849 D	3/16 inch
	15824 G	15849 D	7/32 inch
	15824 H	15849 E	15/64 inch
	15824 G	15849 E	17/64 inch
15800 E, 15800 G	15824 E	15849 D	1/16 inch
	2324 Q	15849 D	1/8 inch
	15824 E	15849 E	7/64 inch
	2324 Q	15849 E	11/64 inch

KNIFE GRINDER

DESCRIPTION There are two types of knife grinders. No. 15898 B is for knives used with the spring-pressed knife engagement trimming mechanism as found in styles in Class 13200 and Styles 15800 A and 15800 B. No. 15898 D is for knives used with the fixed knife engagement trimming mechanism as found in Styles 15800 D, 15800 E, and 15800 G.

INSTALLATION Knife grinders are not included in standard equipment, but either type can be furnished at the price listed. It may be set on the sewing machine table and driven by an ordinary

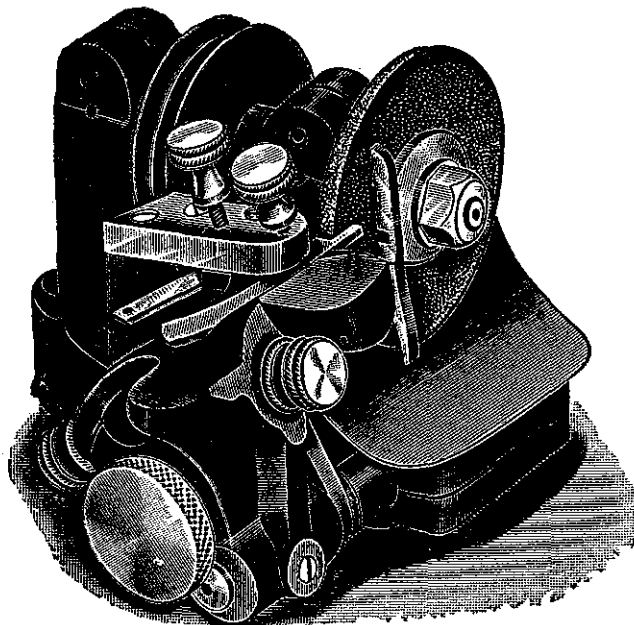

15898B

transmitter or may be driven from an overhead shaft. If a transmitter is used, it should be fastened to the underside of the table slightly back of the grinder so that the front part of the belt will not interfere with the grinder frame.

SPEED The diameter of the grinder pulley is two inches. To make a smooth cutting edge and leave the burrs on the opposite side, the top of the wheel should turn toward the cutting edge of the knife. The speed of the emery wheel should be at least 3500 R.P.M., but not exceed 5000 R.P.M., although it may be safely driven at 8000 R.P.M. A speed of less than 3500 R.P.M. will allow the knives to cut the emery wheel, while a speed greater than 5000 R.P.M. will require exceptionally great care to avoid drawing the temper.

GRINDING THE KNIVES A swinging frame adjustable to and from the emery wheel by a thumb screw, is provided to automatically position the knives at the correct angle. Light cuts should be taken otherwise the temper of the knife will be drawn.

KNIFE GRINDER

The upper and lower knives should be ground alternately for the reason that grinding the lower knife tends to keep the right-hand corner of the emery wheel square.

If the emery wheel becomes rounded, an emery wheel dresser or a coarse file should be applied; the latter can be used only by turning the wheel by hand.

It is not advisable to use this knife grinder for scissors, tools, or machine parts. A small utility grinder No. 21394 can be furnished at a slight cost for miscellaneous grinding.

If preferred, the knives may be sent to our nearest office, where the grinding will be done promptly for a nominal charge.

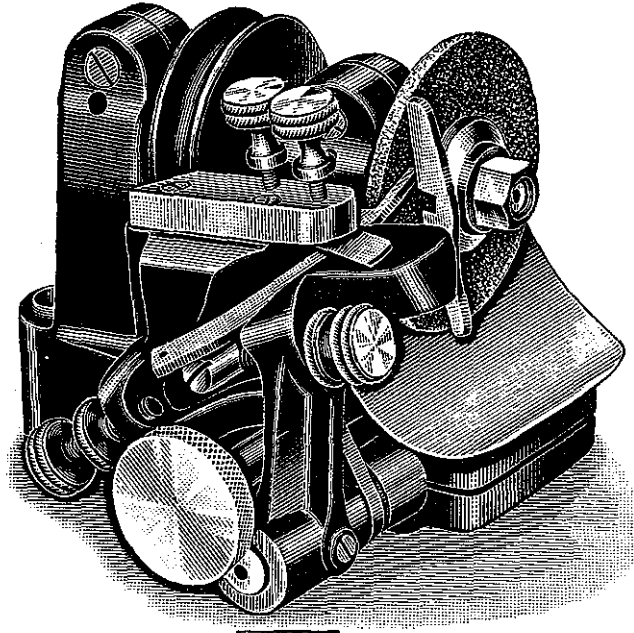

15898 D

GRINDING LOWER KNIVES The lower knives, used with both types of trimming mechanism, are ground in practically the same manner. Clamp the knife in the left opening of the swinging frame and swing the knife across the face of the wheel. If after taking a cut to the left and back to the right across the end of a dull knife, it is not found sharp enough, unclamp the knife, push it against the positioning lever, reclamp it, raise the lever and take another cut. This method will permit additional cuts of the same size without any danger of grinding away the frame or drawing the temper. Care should be taken to see that the looper clearance is maintained on lower knives used with the fixed knife engagement trimming mechanism.

To those accustomed to grinding knives, the positioning lever may be dispensed with and the thumb screw used, thereby simplifying the operation.

GRINDING UPPER KNIVES There is considerable variation in the design of the upper knife used with each type of trimming mechanism. They are therefore taken up separately.

KNIFE GRINDER

The upper knife, used with the spring-pressed knife engagement trimming mechanism, is clamped in the right-hand opening. The stop regulating screw should be set to avoid cutting away the guiding toe. To secure a square corner between the cutting edge and guiding toe, the right-hand corner of the emery wheel should be kept square.

The length of the guiding toe should be equal to the travel of the upper knife plus $\frac{1}{8}$ inch.

The above applies to the upper knife, used with the fixed knife engagement trimming mechanism. The bevel of this knife should be maintained to the extent that its cutting edge will not exceed $\frac{1}{32}$ inch in thickness. The bevel on the right-hand side of the front edge should also be maintained to deflect the parings where heavy cuts have to be taken. When the left side of the guiding toe becomes worn so that its thickness is noticeably reduced, it will be preferable to grind off the toe and make an entirely new cutting edge.

REPAIRING

LAPPING BEARINGS Use only powdered oil stone for this process. When finished, clean the parts thoroughly with gasoline and run them in oil.

Powdered emery or crocus should never be used because they cannot be thoroughly washed out, and what is retained in the pores of the metal will continue indefinitely the grinding process.

The bearings of the needle lever connection and all similar parts are left a trifle small to allow for their being lapped together with their associated parts.

PLUS SIZES The main shaft, needle lever stud, feed rocker shaft, presser bar, and presser guide bar are made in plus sizes for use where bearings have been worn (see list of parts).

In assembling a plus size needle lever stud in a needle lever, ream the needle lever with taper reamer No. Y 800 allowing $1/32$ inch from inside of stud head to hub face of needle lever for lapping in. Clean thoroughly after lapping together.

In assembling a plus size needle lever stud in machine frame, place the needle lever and stud in position and note how far the stud extends. Remove and ream bed with taper reamer No. Y 801 till the space between the inside of the stud head and the hub face of needle lever is $7/32$ inch when the needle lever is held against the frame. Draw the needle lever stud into position by turning the nut.

RENEWABLE BEARINGS These are provided for the needle bar. Being retained in position by a clamp screw, they can be easily replaced when worn. It is advisable to use bearings with an internal diameter of .197 inch and ream them to the standard internal diameter .200 inch after they are clamped in position. Without specific instructions regarding their internal diameter, they will be furnished to fit the needle bar of standard size .200 inch.

CAUTION Care should be taken to avoid breaking the frame when removing a bearing. Do not pry open the slit with a screw driver or similar tool. A better plan is to loosen the screw and push or tap it out from the under side.

TENSION NUTS When a nut becomes too loose to maintain its position, turn it on the post as far as possible, and slightly spread the slotted end.

REPAIRING

FEED BAR SHOE A reversible hardened steel shoe is secured to the underside of the feed bar to take the wear of the feed lift eccentric.

SHARPENING FEED DOGS When the teeth of a feed dog have become dull, it may then be annealed, re-sharpened and re-hardened. For removing sharp edges of the teeth, a small triangular piece of oil stone will be found convenient.

ASSEMBLING To maintain the take-up and eccentric in proper relation, the main shaft is spotted. The position of these parts must not be changed.

Beginning with the eccentrics at the left, the feed lift eccentric is assembled with its catalog number to the right. The looper eccentric is likewise assembled with its catalog number to the right. In styles in Class 13200 and Styles 15800 A and 15800 B, the knife eccentric is assembled with its hub to the left; the second screw coming into view as the eccentric is turned in its operative direction, is placed in the time spot. The take-up is assembled so that its edges will rotate in the following order: (1) Long straight edge, (2) circular edge, and (3) short straight edge. The needle lever eccentric and balance weight is assembled with the balance weight on the right; the first screw coming into view as the balance weight is turned in its operative direction is placed in the time spot. In Styles 15800 D, 15800 E and 15800 G, the knife eccentric is assembled with its hub to the right; the first screw coming into view as the eccentric is turned in its operative direction, is placed in the time groove. The hub of this eccentric serves as a collar and the groove in the shaft permits lateral adjustment. The remaining styles not having this knife eccentric to the right of the needle lever eccentric, have a collar which is placed against the frame to prevent end play to the right. Before tightening the set screw in the collar or knife eccentric, place two pieces of newspaper between the hub of the needle lever eccentric and the middle bearing; slide the main shaft so that the paper is pressed against the bearing and hold firmly in this position till the knife eccentric or collar, as the case may be, is secured in position, snug against the frame. Withdraw the paper; this will provide the proper clearance between the eccentric and bearing. The machine pulley is then placed on the right-hand end of the main shaft and brought snug against the frame, thus preventing end play to the left.

The needle bar is fitted correctly in its bearings when it falls slowly of its own weight. The needle lever stud should be tightened so that the left end of the lever also falls slowly of its own weight

REPAIRING

If, after connecting the lever with the needle bar, the parts do not fall, obviously the lever is not in line. By withdrawing the needle lever link, the direction in which the lever should be bent can be readily seen.

The tube, No. 1230 C, of the needle lever connection should be adjusted so that the distance between the centers of the needle lever eccentric and needle lever ball stud is $4\frac{3}{4}$ inches.

The needle lever ball should be turned so that a small space will be left between the buffer and the upper bearing when the bearing is at its highest position. Tighten the clamp nut securely.

NEEDLES

TYPE NUMBER Each needle has a type number and size number. The former denotes the kind of point, shank, length, groove, finish, and other details. The latter denotes the largest diameter of the blade, measured in thousandths of an inch, midway between the shank and eye, and is stamped on the needle shank. Collectively, the Type Number and Size Number represent the complete definition of the needle.

The Type Numbers of the needles used on the styles of machines covered by this catalog are listed below. Set opposite each Type Number is the definition of the needle.

Type No.	Definition
106	Round shank, round point, extra short, double groove, ball eye, nickel plated.
121	Round shank, round point, short, double groove, nickel plated.
128	Round shank, round point, short, double groove, ball eye, spotted, nickel plated.

APPLICATION OF TYPE NUMBERS The styles of machines covered by this catalog are listed herewith. Set opposite each style number is the Type Number of the needle generally used.

Machine Style No.	Type No. of Needle Used	Machine Style No.	Type No. of Needle Used
13200 A	106	15800 G	121
15800 A	106	15900 A	128
15800 B	106	15900 D	106
15800 D	121	15900 E	106
15800 E	121		

USE GENUINE NEEDLES Success in the operation of these machines can be secured only by the use of genuine Union Special Needles, as furnished by the Union Special Machine Company, or its subsidiaries. Obviously, it is to our interest to maintain the reputation of machines by furnishing the very best needles obtainable. They are designed according to the most approved scientific principles and are made with the utmost precision. The maximum efficiency and durability are assured.

Genuine needles are put up in packages marked at the top "Trade 'UNION SPECIAL' mark." All other needles are bogus.

ORDERING To have orders promptly and accurately filled, the empty package, a sample needle, or the Type and Size Numbers should be given. See marks on package. An intelligible order would read as follows:

100 Needles Type 121 Size .040.

ORDERING REPAIR PARTS

PLATES Illustrations of parts similar in appearance and size are shown in groups.

LIST OF PARTS Turning from the plates to the list of parts, the definition of each part and its principal uses will be found. Always check the symbol against its definition before ordering. It is not necessary to furnish the plate number.

When a part is used in all machines covered by this catalog, no specific use is mentioned in the definition.

For convenience in ordering, minor parts, such as screws, nuts, and similar articles are repeated after each major part.

(—) A dash in the "plate number" column of the list of parts indicates the absence of an illustration.

(□) A square in the "Symbol to order by" column indicates that the part is commercial and can be readily purchased in any machinists' supply house.

(‡) A double dagger in the "Symbol to order by" column indicates that the component parts cannot be furnished separately.

(∠) An angle in the "Symbol to order by" column indicates parts for Styles C and F thread stands. In Style C stand, the spool seats are integral, while in Style F stand, the spool seats are separate. The illustration on page 3 in Catalog No. 51 A shows the Style F stand.

IDENTIFYING PARTS Where the construction permits, each part is stamped with its part number. Some of the smaller parts are stamped with an identification letter to distinguish them from parts similar in appearance.

All part numbers represent the same part regardless of the catalog in which they appear.

SUPPLIES All supplies, including taps, reamers, belting, belt hooks, belt fasteners, screw drivers, and powdered oil stone will be promptly furnished.

TERMS Prices are strictly net cash and subject to change without notice. Express and freight shipments are forwarded at the buyer's risk f. o. b. shipping point. Parcel post shipments are insured unless otherwise directed. A charge is made to cover the postage and insurance.

Plate 1—Full Size

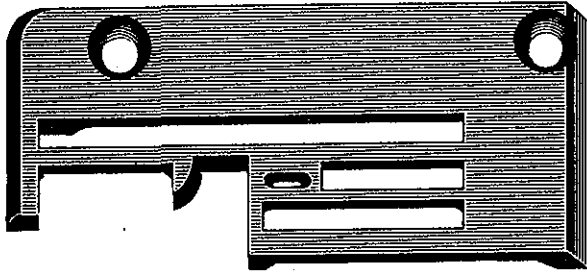

15824 C

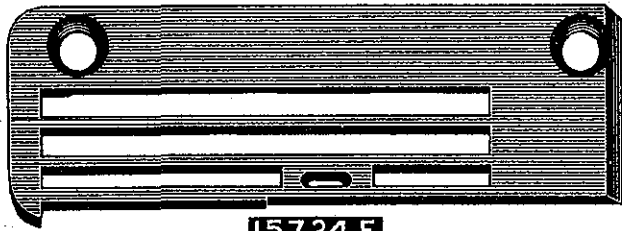

15724 E

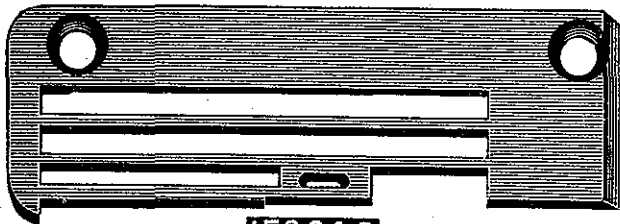

15824 D



15824 G

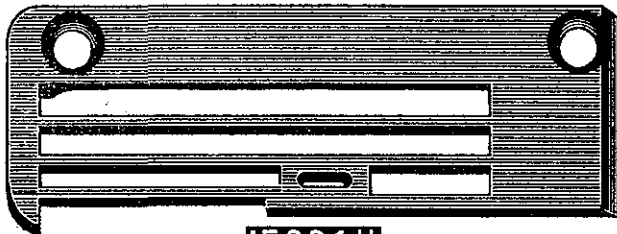

15824 H



15825

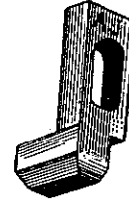

5125

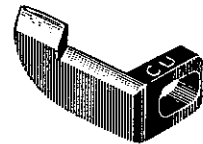

15825 A

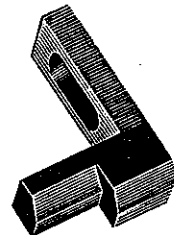

13225

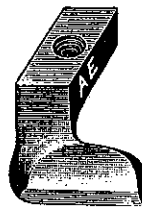

196 D

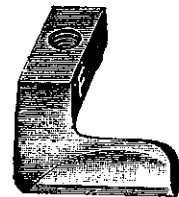

196

Plate 2—Full Size

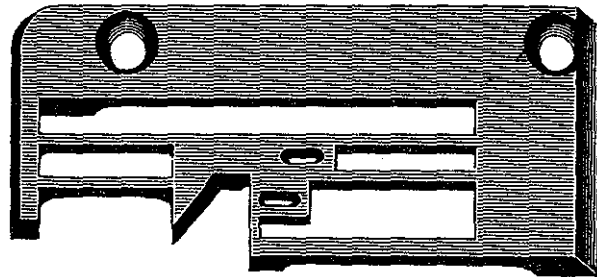
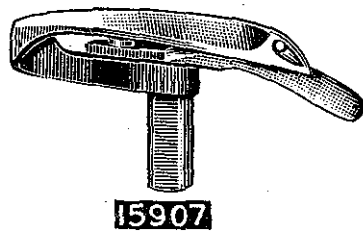
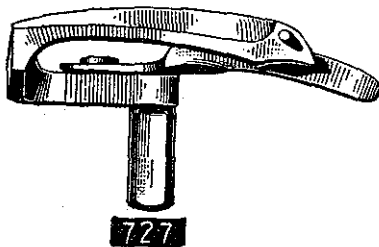
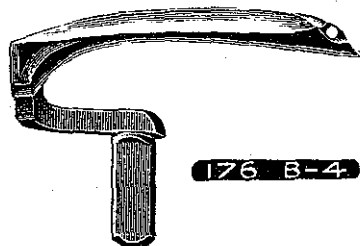
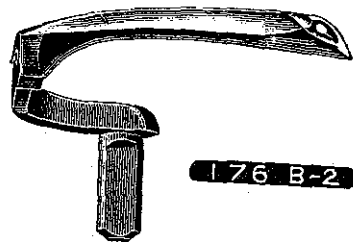
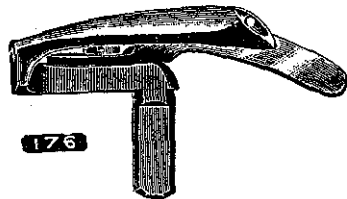
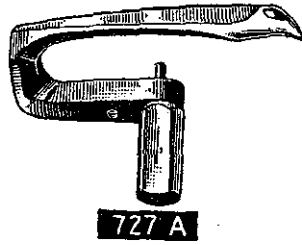

13224 A

Specify
Gauge

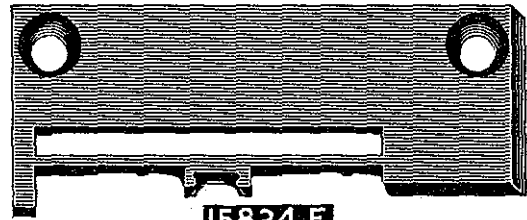

15824 E

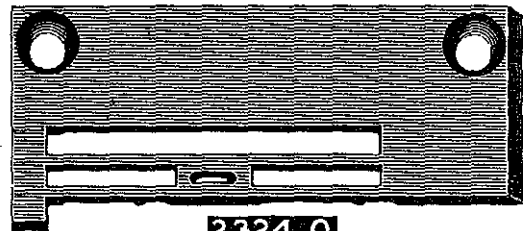

2324 Q

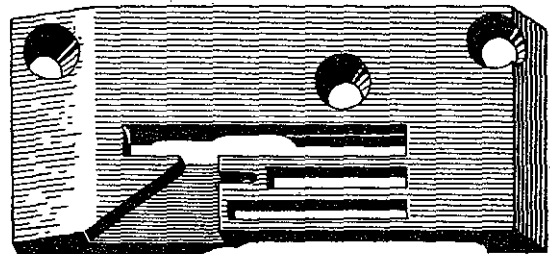

15924 D

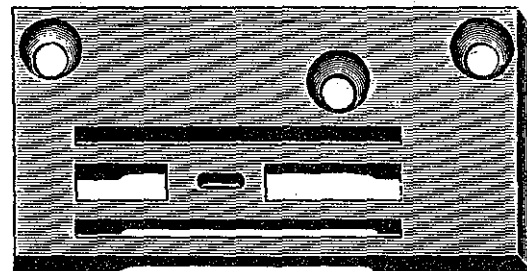

9224 E

Plate 3—Full Size

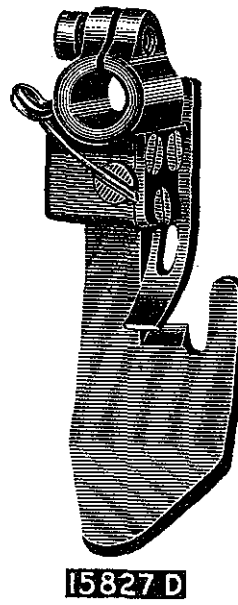
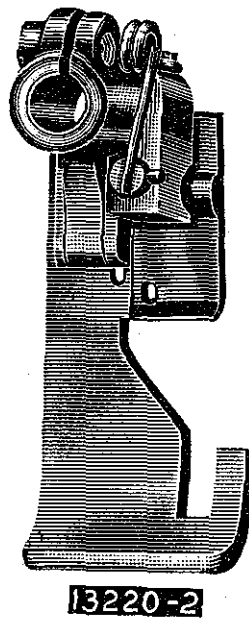
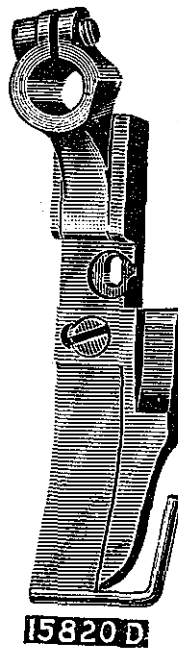
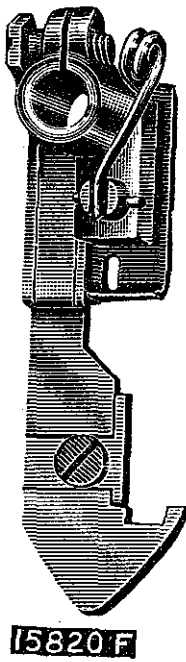
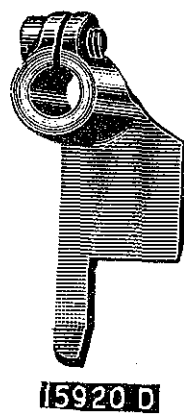
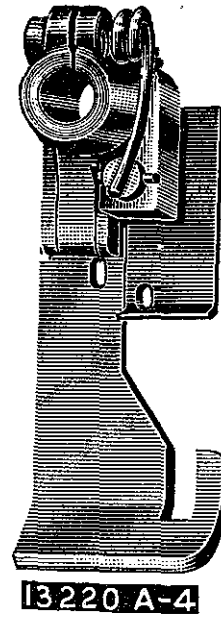
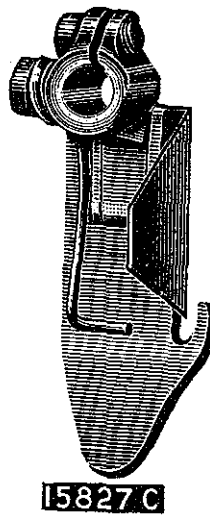
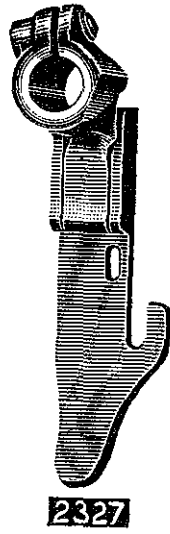
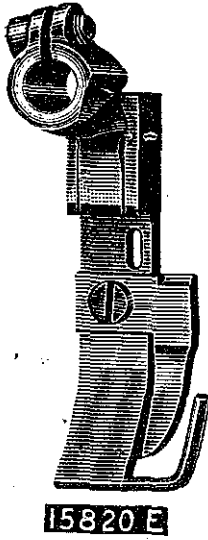
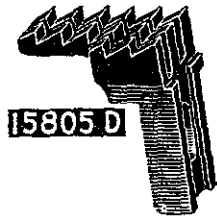
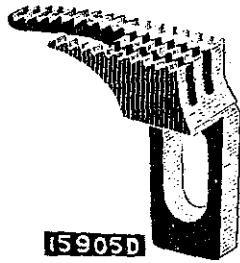

Plate 4—Full Size



15805 D



15905 D

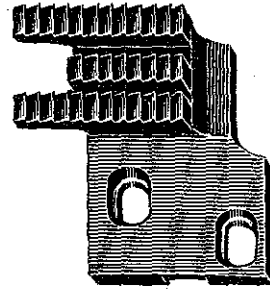

15805 G

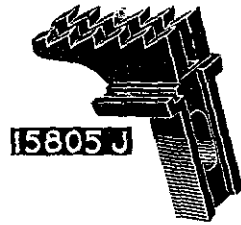

15805 J



15826 A

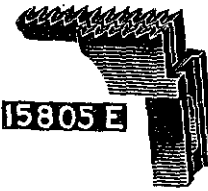

15805 E



15805 K

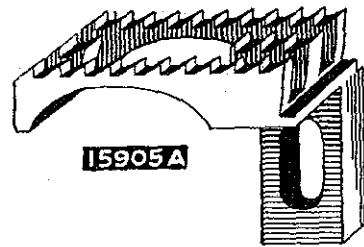

15905 A

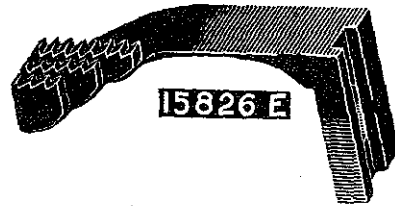

15826 E

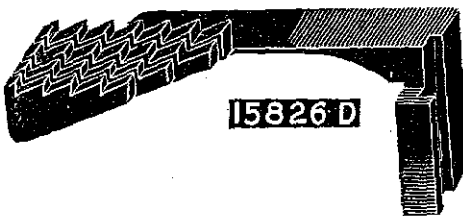

15826 D

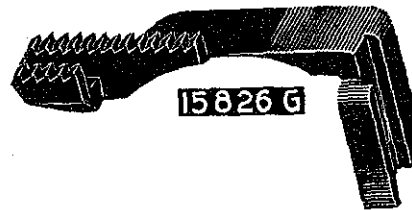

15826 G

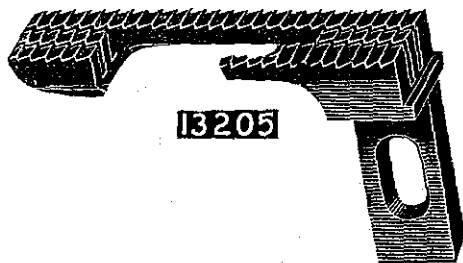

13205

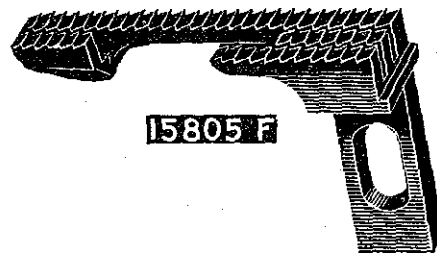

15805 F

Plate 5—Full Size

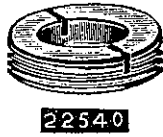

Plate 6—Full Size

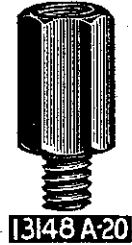
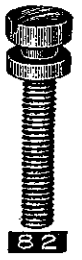
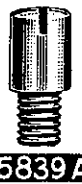
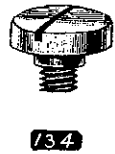
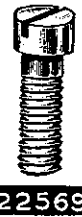
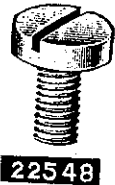

Plate 7—Full Size

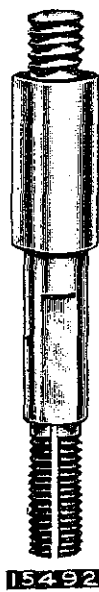
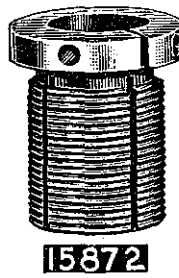
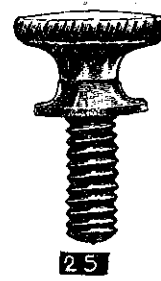
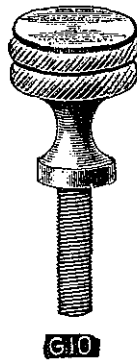
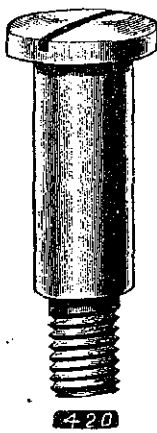

Plate 8—Full Size



12982



12934A



18



258



269



41071G

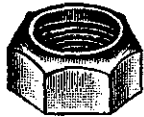

15430 D



15430 C



615



47



21104 H



15887



5144



15433



64 B



21185



108



T14



107



13218

Specify
Gauge



161

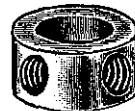

12865

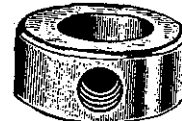

267



84 A



15872 C



1347



11261 B

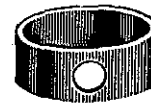

15886



1286



1286 A



15436



2113 B

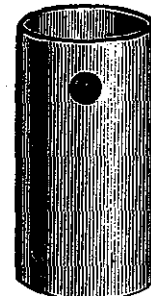

2338

Plate 9—Full Size



15882 A

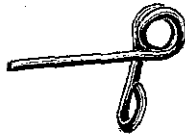

1914.6 A



15882

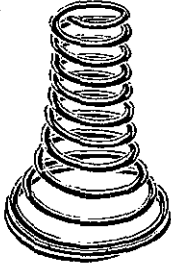

1349 A-4

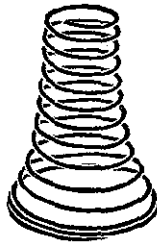

1349 A-3

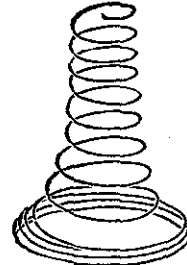

1349 A-0



1588



15866 C



21104 J



360



15489 C

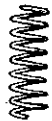

1230 B



15872 J

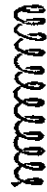

1286 B

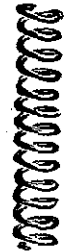

15458 D



15458 J

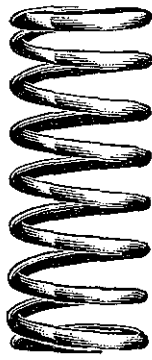

15877



426



15872 F



15867 E

Plate 10—Full Size

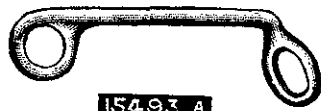

15493 A



15435 N



15835 D

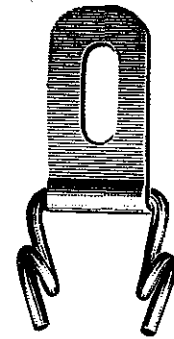

15835 C

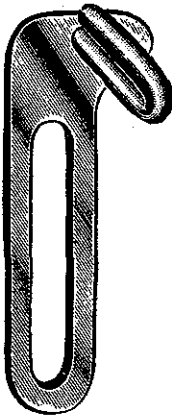

15435 G



15595 F

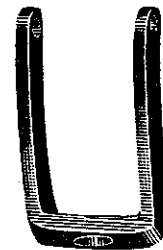

15854 A

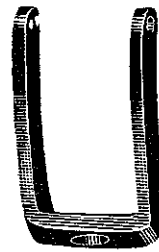

13254



35582 B



15595 B



337



12954



336

Plate 11—Full Size



14544



15849 A



15870 A



15849 D



15870 D

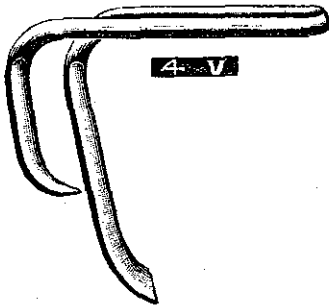

4-V



15849 E

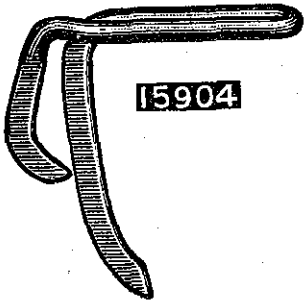

15904



15867 B

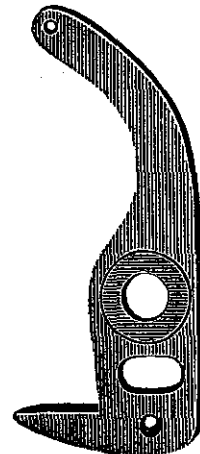

15867 D

Plate 12—Full Size

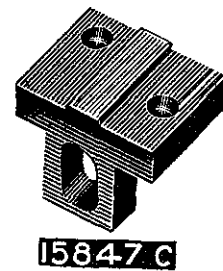
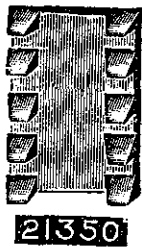
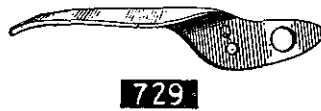
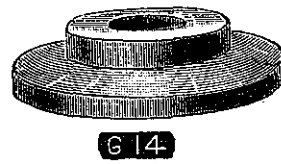
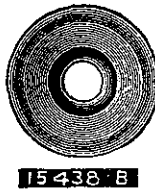
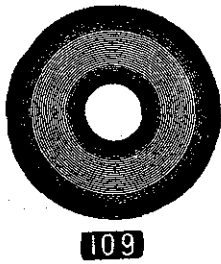
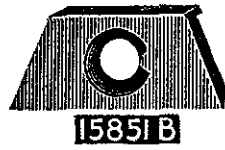
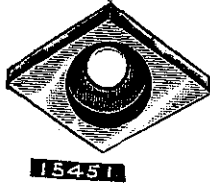
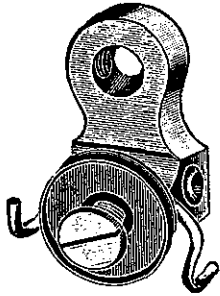
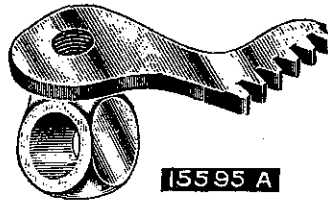

Plate 13—Full Size



15437A



15595 A

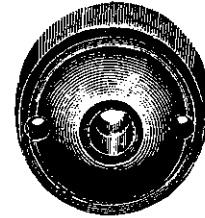

7945



12983

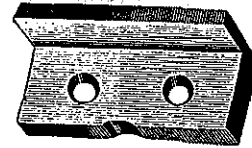

15447 L

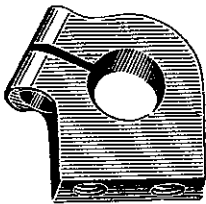

15867 G

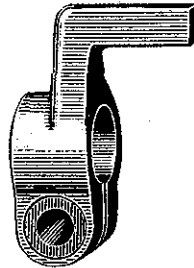

15860

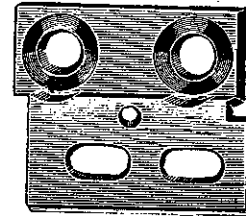

15447K

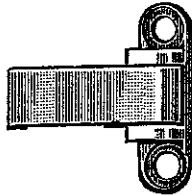

15458 M

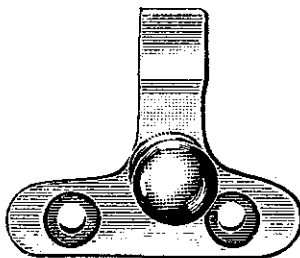

15858 L

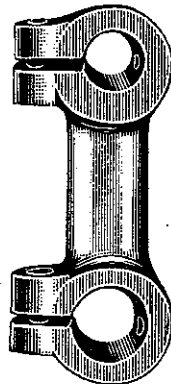

2334

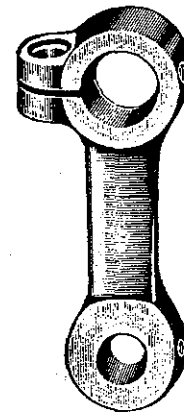

15446 D

Plate 14—Full Size

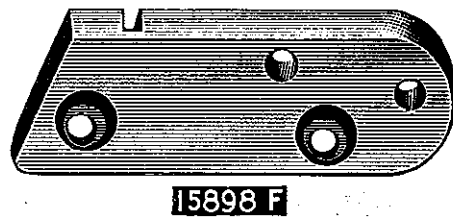
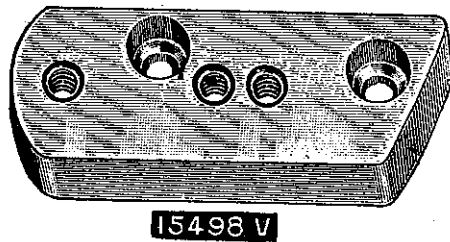
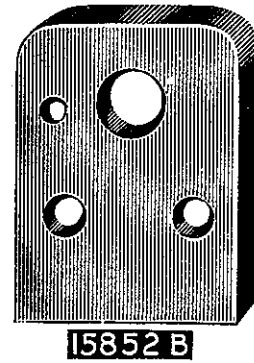
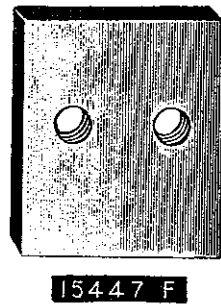
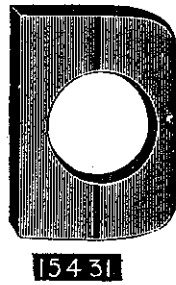
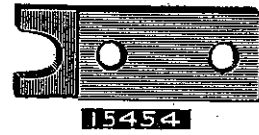
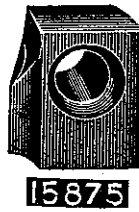
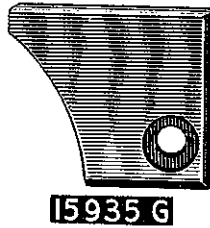
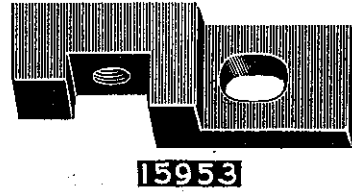
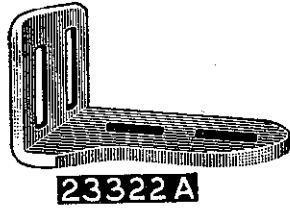
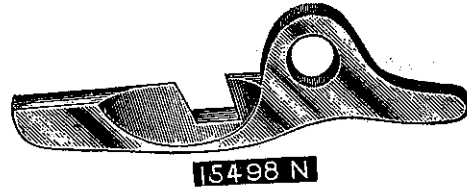

Plate 15—Full Size



21211



15867 C



20



12957 E



43



1362



426 A



1361 A



12964 C



15458 F



23322 M

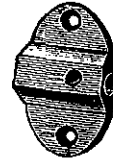

15435 P



15458 H



15498 H



12984



540

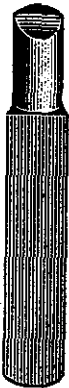

15872 L



V113



V109



V118

Plate 16—One-half Size



15854 B



15867 F



58



364

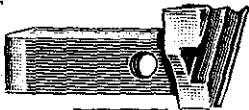

15850



9932



15885



15874

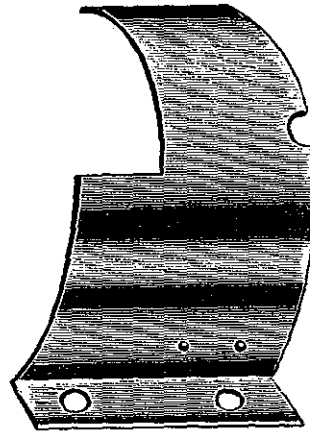

15435 M

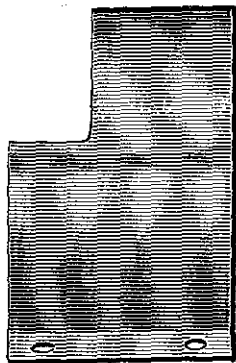

15835 B

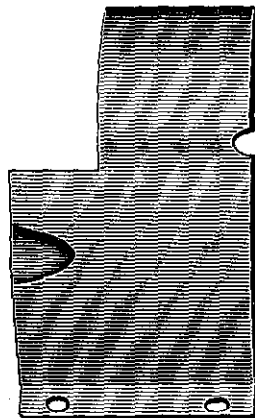

15835

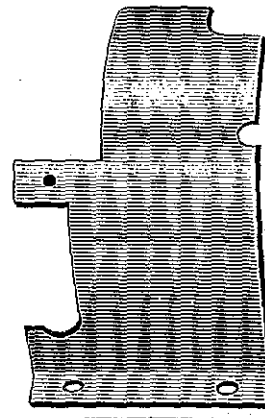

15835 A

Plate 17—One-half Size

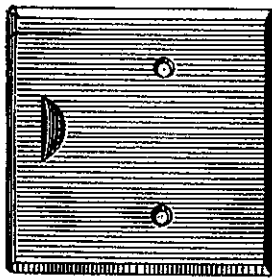

15930

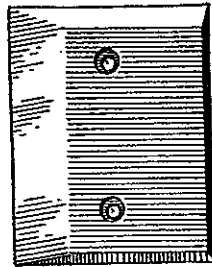

15930A

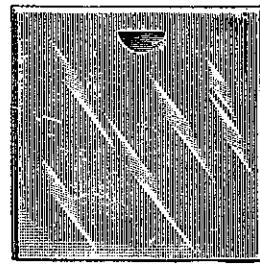

2.A



23322 L



23322 B



23322 P



23322 J
Specify
Gauge



23322 N
Specify
Gauge



23322 C



23322 S

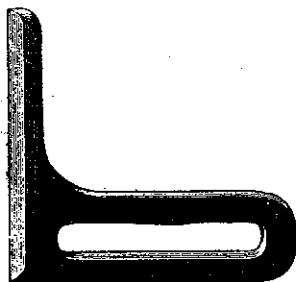

24

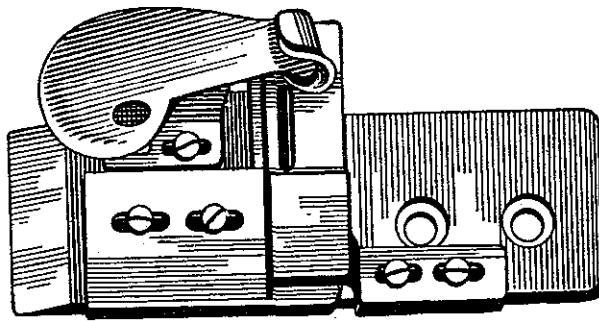

23377

Plate 18—One-half Size

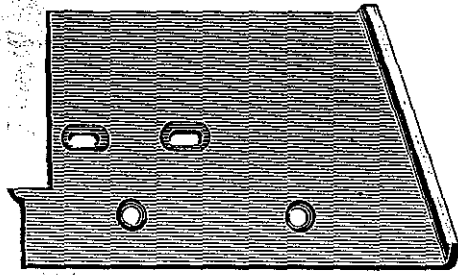

15802

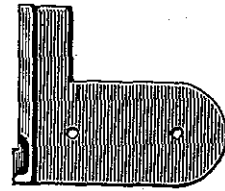

15858M

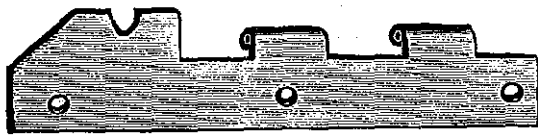

15458

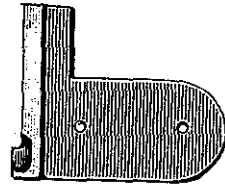

15858N

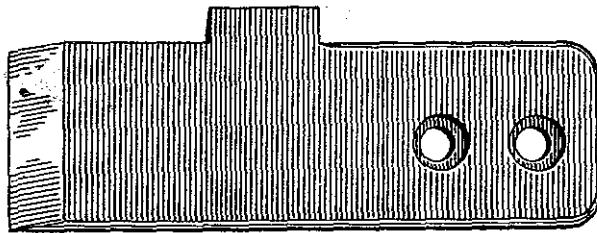

21387D

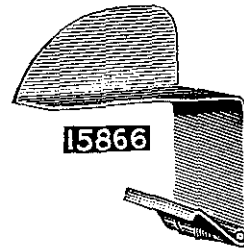

15866

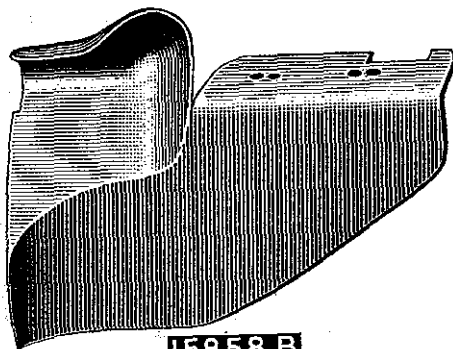

15858B

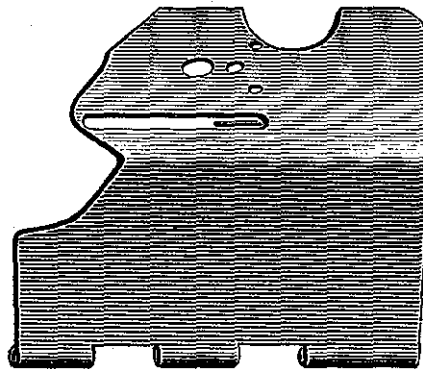

15858C

Plate 19—One-half Size

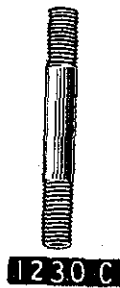
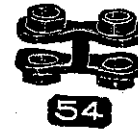
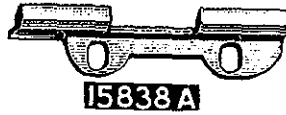

Plate 20—One-half Size



21113 A



13217



15817



4517



41064 B



15872 K



56

Specify
Gauge



15498 G



8



15864



15448



15880 B



892

Plate 21—One-half Size

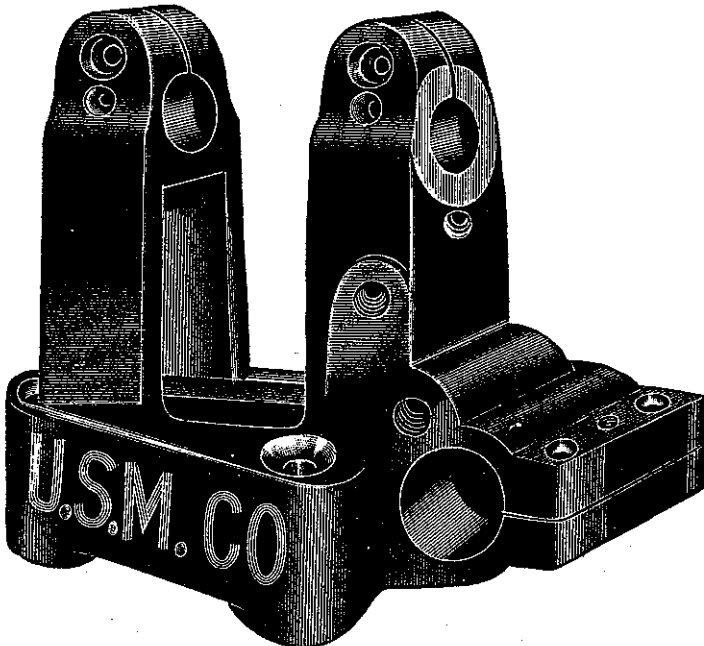
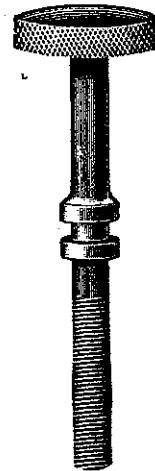
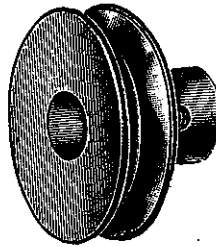
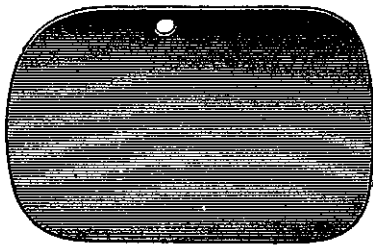
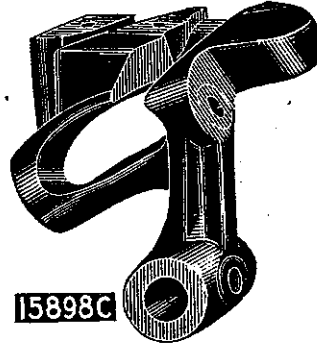
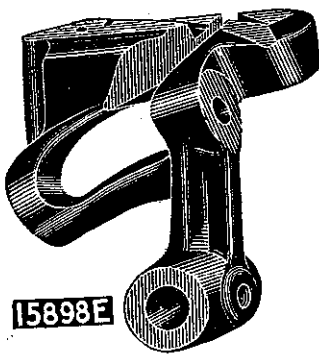

Plate 22—One-half Size

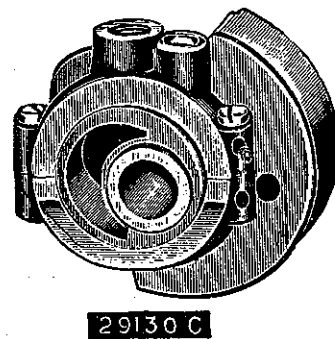
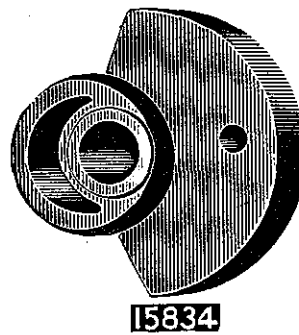
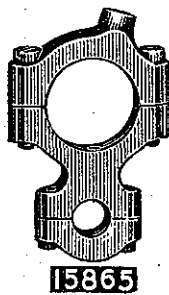
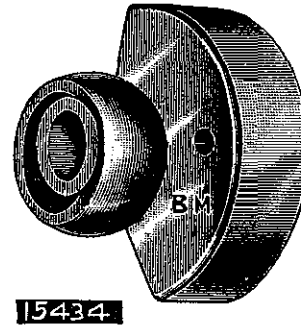
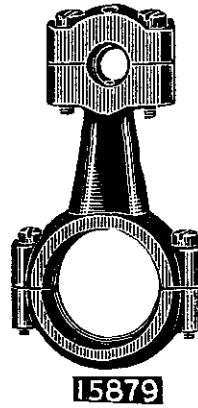
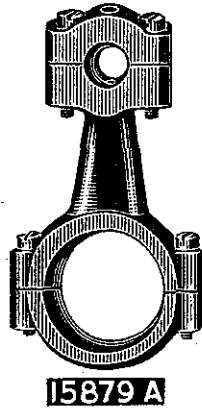
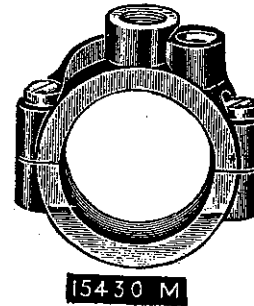
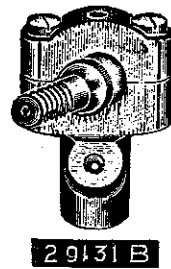
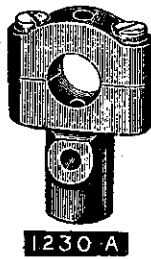
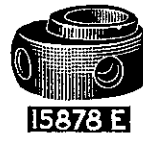
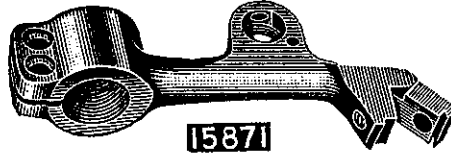
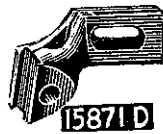
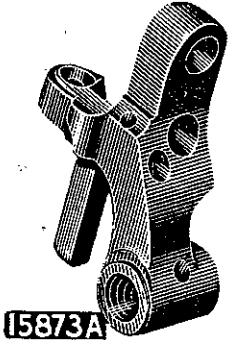
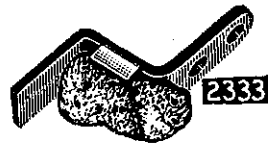
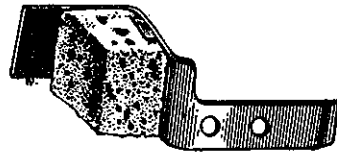
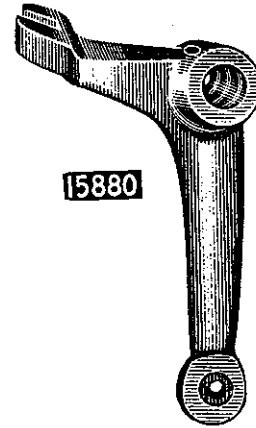
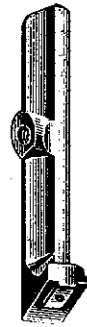
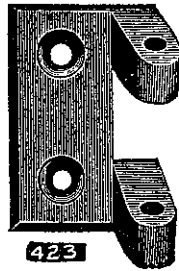
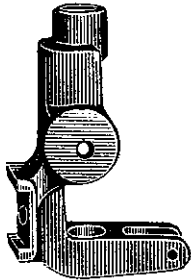

Plate 23—One-half Size



15873 A



15872 A

423

2335

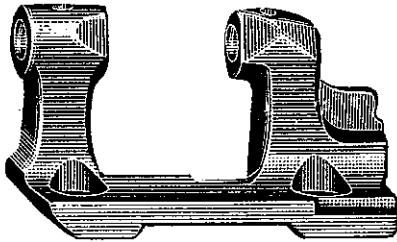

15863

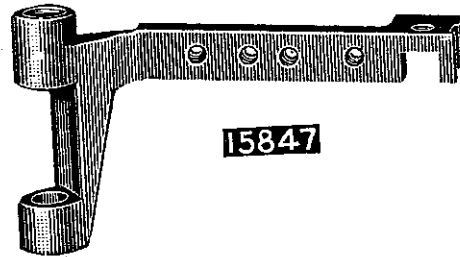

15847

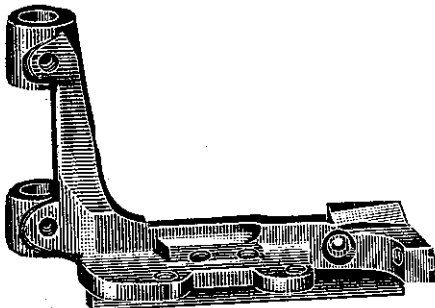

15847 E

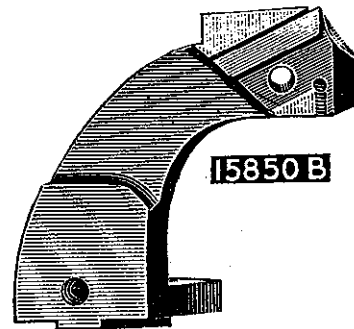

15850 B

Plate 24—One-half Size

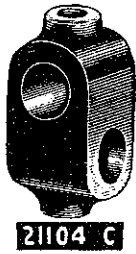
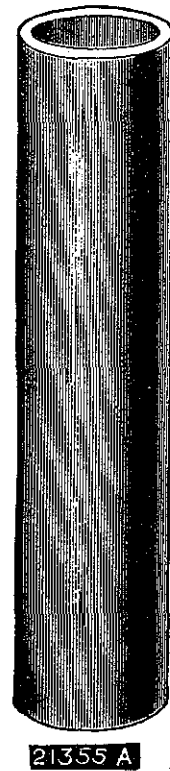
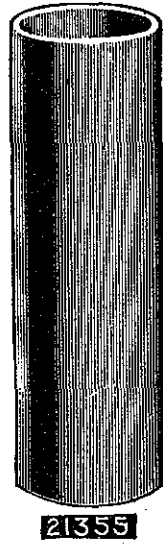
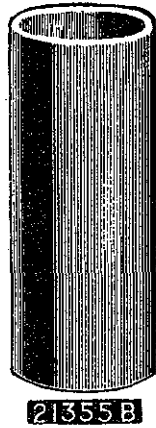
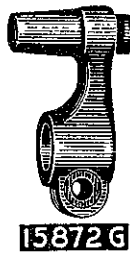
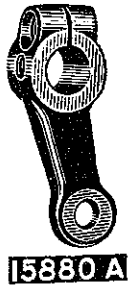
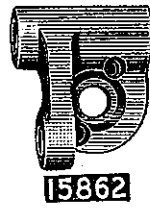
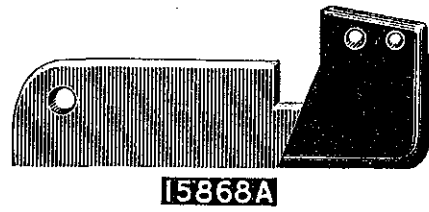
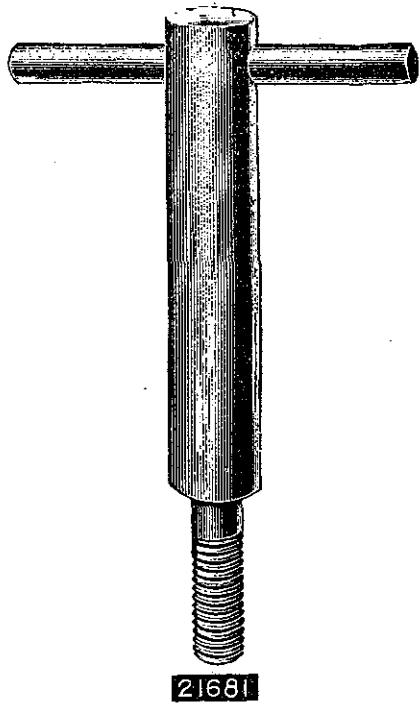
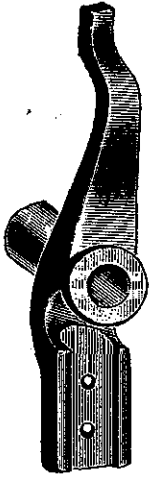

Plate 25—One-half Size



15459



415 B

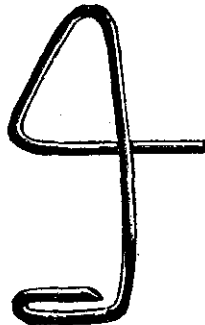

15496 B

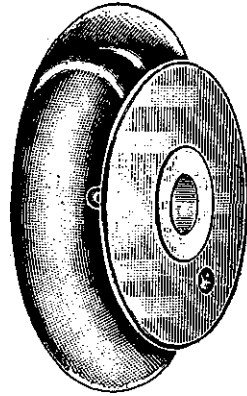

15421



116



15458 A



419 A



15995



118 B



15855 A



1275 A

Plate 26—One-third Size

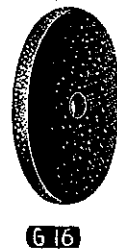
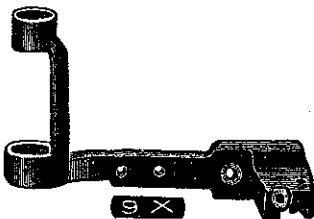
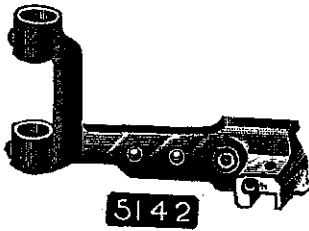
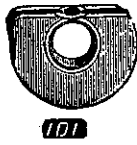
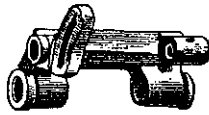
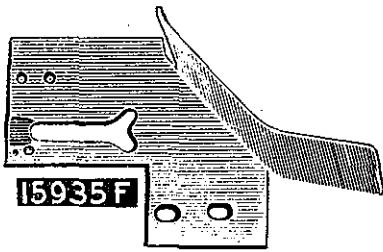
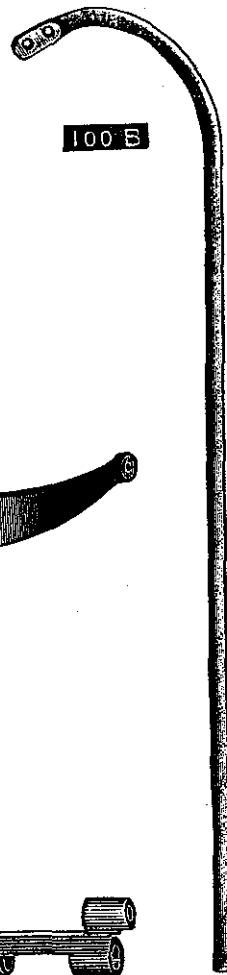

Plate 27—One-fourth Size



5156



100 B

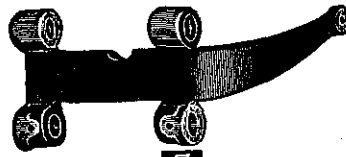
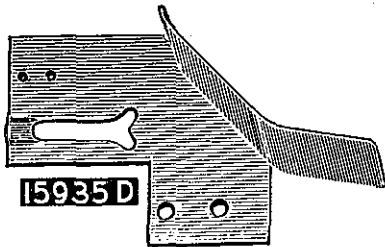

7

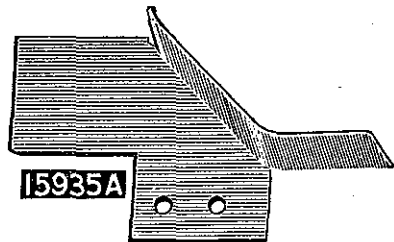

1583 C



5157

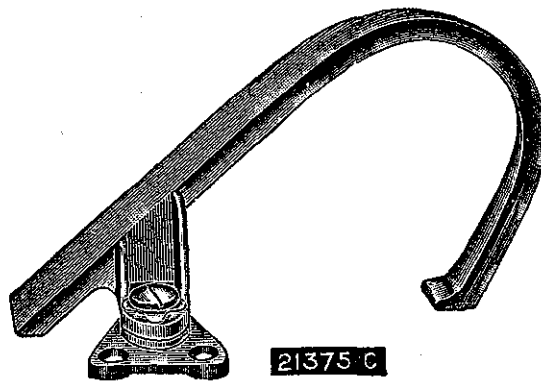

21375 C

Plate 28—One-fourth Size

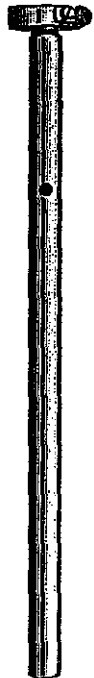

15822



15822A

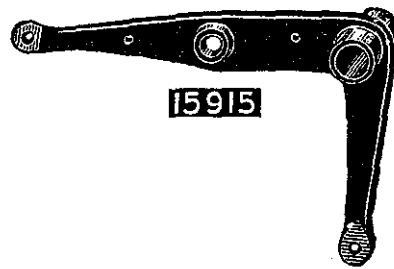

15915



15815



15815D

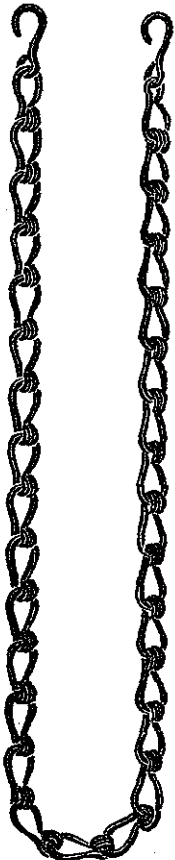

421

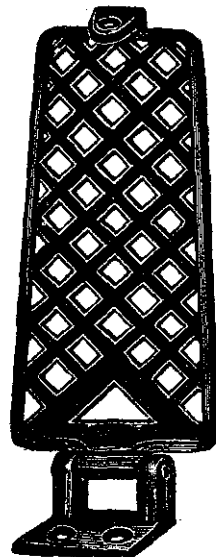

29402

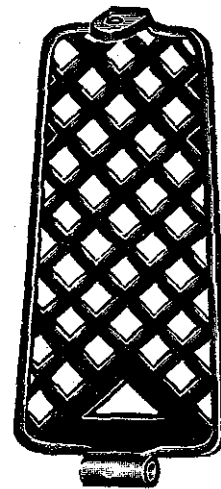

422

Plate 29—One-fourth Size

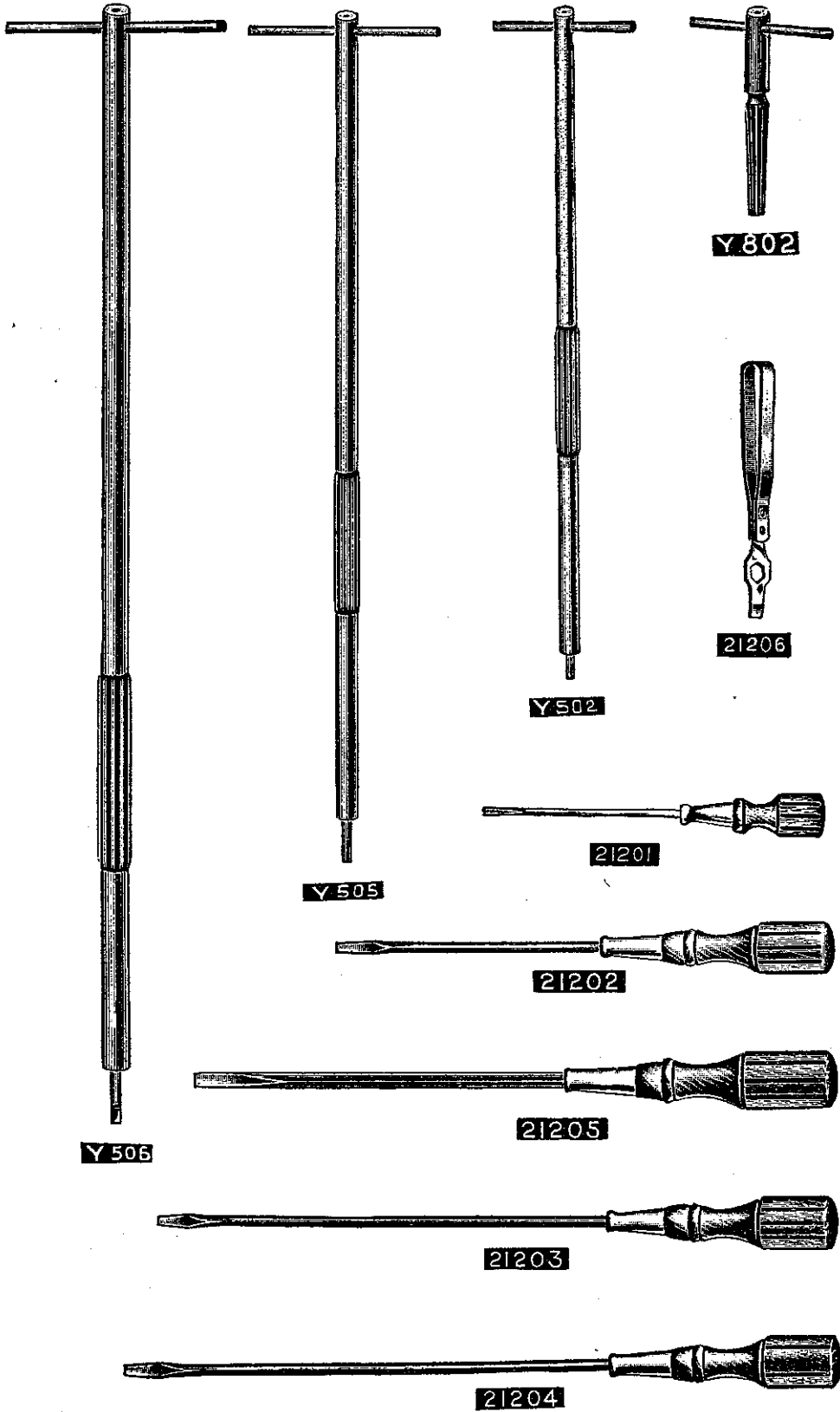
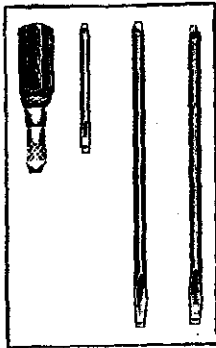

Plate 30—One-eighth Size



21208



21680



695



21104G



21104 K



21104 B

Specify Length

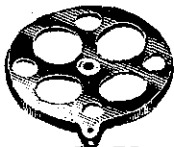

21104 D

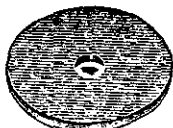

21104 F



21207



21102 D



21104 A

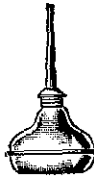

413

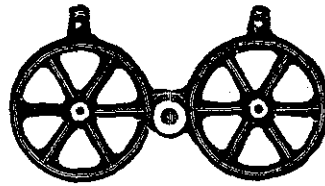

21130 A-2

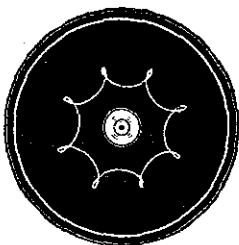

21169 E



21169 F

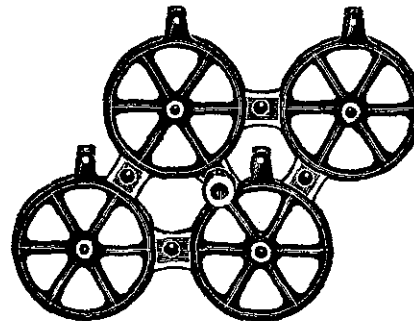

21130 A4

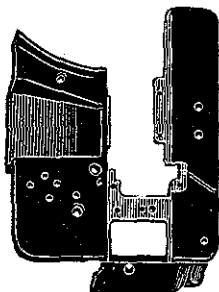

15801 H

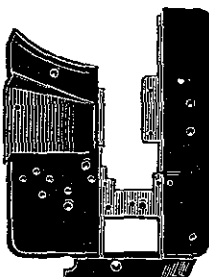

15801 K

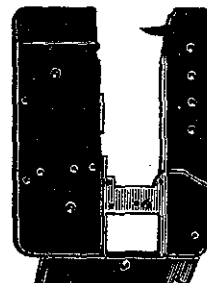

15901

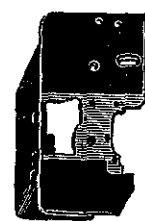

15801 C

LIST OF PARTS

Symbol to Order by	The figures in the last column refer only to the plates illustrating the parts, and are not to be used in ordering. Refer to pink insert for prices.	Plate No.
2 A	Cloth Plate Slide, left, for styles in Classes 13200, 15800; also for Styles 15900 A, 15900 E	17
4 E	Cast-off Wire, for Style 15800 E. Obsolete—Present As- sembly includes Nos. 15904 and 101 V	—
4 V	Cast-off Wire, for Styles 13200 A, 15800 A, 15800 B, 15800 D. Obsolete—Present assemblies include Nos. 15904 and 101 V	11
5	Cast-off Wire Screw No. 87. Main Shaft Collar	19
7	Main Shaft Collar Screws No. 95. Feed Rocker, for styles in Classes 13200, 15900; also for Style 15800 A	27
8	Feed Rocker Screws No. 88. Feed Rocker Shaft, solid, $5\frac{3}{16}$ inches long, hardened and ground, standard diameter .407 inch	20
8-408	Feed Rocker Shaft, standard diameter plus .001 inch	—
8-409	Feed Rocker Shaft, standard diameter plus .002 inch	—
8-410	Feed Rocker Shaft, standard diameter plus .003 inch	—
8-413	Feed Rocker Shaft, standard diameter plus .006 inch	—
8-416	Feed Rocker Shaft, standard diameter plus .009 inch	—
8-419	Feed Rocker Shaft, standard diameter plus .012 inch	—
8-422	Feed Rocker Shaft, standard diameter plus .015 inch	—
9 X	Feed Bar, for styles in Class 15900	26
10	Feed Bar Screws No. 88. Feed Bar Prong and Sponge, for styles in Classes 13200, 15900; also for Style 15800 A	23
10 A	Feed Bar Prong Screws No. 94. Feed Bar Prong Sponge	—
G10	Thumb Screw, for holding knives in knife grinders	7
11	Feed Bar Shaft, solid, $3\frac{7}{16}$ inches long, hardened and ground	19
G11	Pulley, for knife grinders	21
G12	Pulley Screws No. 98. Pulley Spindle, hardened and ground, for knife grinders ...	21
G14	Pulley Spindle Clamp Screws No. 136. Pulley Spindle Washer, for knife grinders	12
T14	Lower Knife Clamp Nut, for Styles 15800 D, 15800 E, 15800 G	8
15	Feed Crank Link, hardened	26
G15	Feed Crank Link Screw No. 79. Pulley Spindle Nut, for knife grinders	8
16	Feed Crank Link Ferrule	19
G16	Emery Wheel, for knife grinders	26
17	Feed Crank Stud	7
18	Feed Crank Stud; also for Nos. 6039, 15864	8

LIST OF PARTS

Symbol to Order by	The figures in the last column refer only to the plates illustrating the parts, and are not to be used in ordering. Refer to pink insert for prices.	Plate No.
19	Feed Crank Stud Cap.....	19
	Feed Crank Stud Cap Screws No. 77.	
20	Feed Crank Stud Washer.....	15
21	Feed Crank Link Pin.....	19
	Feed Crank Link Pin Set Screw No. 77.	
24	Cloth Plate Gauge, for Style 15900 A.....	17
25	Screw, for cloth plate gauge.....	7
25 C	Screw, for cloth plate guard on styles in Class 15900; also for No. 21387 D.....	5
25 CC	Screw, for binder swinging arm support holder; also for Nos. 23322 J- $\frac{3}{4}$, 23322 J- $\frac{1}{2}$, 23322 J-1, 23322 J-1 $\frac{1}{4}$	5
28 A	Set Screw, headless, for needles on Styles 15800 D, 15800 E, 15800 G.....	5
33	Looper Rocker Stud, hardened.....	6
	Looper Rocker Stud Nut, No. 15887.	
41 A	Hand Lifter for Styles 15800 D, 15800 E, 15800 G, 15900 A, 15900 E.....	19
	Hand Lifter Stud No. 86.	
42 A	Hand Lifter Screw Pin, hardened.....	6
43	Feed Lift Eccentric, ground, marked F, throw .062 inch for styles in Class 13200, 15900; also for Styles 15800 A, 15800 B. Obsolete-Present assembly specifies No. 43 C.	—
43 C	Feed Lift Eccentric, ground, throw .080 inch, for Styles in Class 13200, 15900; also for Styles 15800 A, 15800 B....	22
	Feed Lift Eccentric Screw No. 96.	
47	Needle Lever Stud Nut, hardened.....	8
48	Needle Lever Stud Washer.....	15
52 A	Needle Lever Thread Eyelet, for styles in Class 15800....	19
	Needle Lever Thread Eyelet Screw No. 98 A.	
53 A	Needle Bar Thread Eyelet.....	19
	Needle Bar Thread Eyelet Screw No. 605 A.	
54	Needle Bar Link, hardened.....	19
56	Needle Clamp Nut, hardened.....	20
58	Looper Thread Nipper Spring, rear.....	16
	Looper Thread Nipper Spring Screw No. 22542.	
61 X	Presser Bar Connection.....	19
	Presser Bar Connection Screw, front, No. 89.	
	Presser Bar Connection Screw, rear, No. 77.	
62	Presser Guide Bar, hardened and ground, standard di- ameter, .319 inch.....	19
62-322	Presser Guide Bar, standard diameter plus .003 inch.....	—
62-325	Presser Guide Bar, standard diameter plus .006 inch.....	—
62-328	Presser Guide Bar, standard diameter plus .009 inch.....	—
62-331	Presser Guide Bar, standard diameter plus .012 inch.....	—
62-334	Presser Guide Bar, standard diameter plus .015 inch.....	—

LIST OF PARTS

Symbol to Order by	The figures in the last column refer only to the plates illustrating the parts, and are not to be used in ordering. Refer to pink insert for prices.	Plate No.
64	Presser Spring Rest.....	19
	Presser Spring Rest Screw No. 88.	
64 A	Presser Spring Regulating Screw; also for knife grinders..	7
64 B	Presser Spring Regulating Screw Lock Nut; also for knife grinders.....	8
69 S	Thread Stand Pin, 4 inches long; for Style C stand.....	30
∠□69 FD	Set Screw, square head, cup point, $\frac{5}{16}$ inch diameter, 18 threads, $\frac{5}{8}$ inch long, for Style C thread stand seats.....	6
73 A	Screw, for looper needle guards; also for Nos. 15435 N, 15435 P.....	5
75	Clamp Screw, for upper knife on Styles 15800 D, 15800 E, 15800 G.....	6
75 A	Screw, for knife eccentric connection; also for Nos. 15865, 15879, 15879 A.....	6
77	Screw, for lower needle bar link pin on Styles 13200 A, 15800 A, 15800 B, 15900 A, 15900 D, 15900 E; also for Nos. 19, 21, 61 X, 7945, 12983.....	5
77 A	Screw, for feed bar needle rear guard on Style 15800 B; also for No. 15847 A.....	5
78	Screw, upper, for needle bar link pin.....	5
79	Screw, for feed crank link.....	6
81	Spot Screw, for needle lever eccentrics; also for No. 15498 J.	5
82	Screw, for regulating length of stitch.....	6
84 A	Stitch Regulating Ferrule, for styles in Class 13200, 15900; also for Styles 15800 A, 15800 B.....	8
86	Stud, for hand lifters; also or Nos. 15498 N, 15868 A, 23322 C.....	6
86 A	Screw, plus size, for hand lifters, tap No. V113.....	6
87	Screw, for throat plates; also for Nos. 4 E, 4 V, 196, 196 D, 15802, 15904.....	5
87 U	Screw, for binder on Styles 13200 A, 15800 A, 15800 B; also for No. 23322 A.....	5
88	Set Screw, headless, for feed rockers; also for Nos. 9 X, 64, 161, 5142, 12865, 15437 A, 15847, 15847 E, 15862, 21113 B.....	5
88 B	Set Screw, headless, concave end, for needles on Style 13200 A.....	5
89	Spot Screw, for take-ups; also for Nos. 13218-2, 13218-4..	5
90	Screw, for take-up thread eyelet; also for Nos. 15447 K, 15454, 15857, 23322 L.....	5
91	Clamp Screw, fillister head, for presser feet; also for No. 15867 F.....	5
91 A	Screw, for knife guard on Styles 15800 D, 15800 E; also for Nos. 15857, 15881 D.....	5

∠□ See page 25.

LIST OF PARTS

Symbol to Order by	The figures in the last column refer only to the plates illustrating the parts, and are not to be used in ordering. Refer to pink insert for prices.	Plate No.
93	Screw, $\frac{7}{16}$ inch long, for cast-off wire bracket; also for Nos. 15447 F, 15447 J, 15451, 15847 C, 15871 D, 15872 G, 15876, 15905 A, 15905 D.....	6
93 A	Screw, $\frac{9}{32}$ inch long, for lifter lever extension; also for No's. 13205, 15805 F, 15835, 15835 A, 15498 H, 15847 A..	6
94	Screw, for feed bar prongs; also for Nos. 5125, 9932, 13225, 15435 G, 15447 J, 15493 A, 15835 B, 15838 A.....	6
95	Set Screw, for needle lever eccentrics; also for Nos. 5, 100 B, 336, 15493 B, 15878, 15878 D, 15878 E, 21113 A.....	5
96	Spot Screw, for feed lift eccentrics; also for Nos. 13214, 15814, 15878, 15880 A.....	5
97	Screw, for supporting feed dogs on non-differential feed machines; also for Nos. 2334, 15860, 15872 B, 15872 L..	6
97 A	Screw, for looper connecting rod ball joints; also for No. 15865.....	6
98	Set Screw, for knife grinder pulley; also for Nos. 267, 424, 482.....	5
98 A	Screw, for needle lever thread guides; also for No. 15496 B..	5
∠100 B	Thread Stand Wire, 16 inches long, for Style C thread stand.....	27
	Thread Stand Wire Screw, 32 threads to inch, No. 95.	
	Thread Stand Wire Screw, 24 threads to inch, No. 22813.	
101	Take-up, for looper thread. Obsolete—Present assemblies include Nos. 101 V and 15904.....	26
101 V	Take-up, for looper thread.....	26
	Take-up Screw No. 89.	
107	Tension Spring Ferrule.....	8
108	Tension Nut.....	8
109	Tension Disc, hardened and lapped.....	12
V109	Tap, marked "J2" for No. 22526.....	15
V113	Tap, marked "Q2" for No. 86 A.....	15
116	Wrench, $\frac{9}{32}$ inch, hardened, for needle clamp nut.....	25
118 B	Thread Tweezers.....	25
V118	Tap, marked "X2" for No. 22521.....	15
134	Screw, for binding cutter lower knife.....	6
136	Screw, for looper rock shaft frame; also for Nos. G12, 15498 J, 15850 B, 15873, 15873 A.....	6
161	Binding Holder Disc Supporting Collar.....	8
	Binding Holder Disc Supporting Collar Screw No. 88.	
176	Looper, front, with guard, for Style 13200 A.....	2
176 B-2	Looper, back, for No. 2 gauge Style 13200 A.....	2
176 B-4	Looper, back, for No. 4 gauge, Style 13200 A.....	2
	Looper Set Screw No. 22565.	
179	Looper Needle Guard, marked "E", for looper No. 176... Looper Needle Guard Screw No. 73 A.	12

∠ See page 25.

LIST OF PARTS

Symbol to Order by	The figures in the last column refer only to the plates illustrating the parts, and are not to be used in ordering. Refer to pink insert for prices.	Plate No.
181	Looper Rocker, hardened, for styles in Class 15900; also for Styles 15800 A, 15800 B, 15800 E, 15800 G.....	26
182	Looper Rocker, hardened, for Style 13200 A.....	26
187 A	Screw, for looper thread guide on Styles 15800 D, 15800 E, 15800 G; also for Nos. 15858 M, 15858 N, 15881 A....	5
196	Throat Plate Needle Rear Guard, hardened, marked "F", for Style 15900 A.....	1
196 D	Throat Plate Needle Rear Guard, hardened, marked "AE", for Styles 15900 D 15900 E.....	1
	Throat Plate Needle Rear Guard Screw No. 87.	
213	Looper Rocker, hardened, for Style 15800 D.....	26
223 C	Screw, for binding cutter upper knife.....	6
258	Upper Knife Lever Ball Nut.....	8
267	Collar, for knife grinder swinging frame pivot pin.....	8
269	Looper Connecting Rod Nut, left thread.....	8
330 A	Main Shaft Sleeve, $\frac{19}{64}$ inch long, for Styles 13200 A 15800 A, 15800 B.....	19
336	Tension Thread Eyelet, for styles in Classes 15800, 15900.. Tension Thread Eyelet Screw No. 95.	10
337	Tension Thread Eyelet, one eye; Obsolete—Replaced by No. 336.....	10
364	Looper Thread Nipper Spring, front.....	16
	Looper Thread Nipper Spring Screw No. 22542.	
380	Cloth Plate Extension Spring Latch, for styles in Class 15900; also for Styles 15800 E, 15800 G.....	9
	Cloth Plate Extension Spring Latch Screw No. 22564 A.	
413	Oil Can, with spout.....	30
413 A	Oil-Can Spout.....	—
415 B	Lifter Lever Casting.....	25
419 A	Lifter Lever Extension.....	25
	Lifter Lever Extension Screws No. 93 A.	
420	Lifter Lever Stud.....	7
421	Lifter Lever Chain.....	28
422	Lifter Treadle.....	28
423	Lifter Treadle Rest.....	23
424	Lifter Treadle Pin.....	19
	Lifter Treadle Pin Set Screw, 32 threads to inch, No. 98.	
	Lifter Treadle Pin Set Screw, 24 threads to inch, No. 22813.	
426	Lifter Lever Spring.....	9
426 A	Lifter Lever Spring Pin.....	15
482	Upper Knife Bar Shaft Collar, for Styles 13200 A, 15800 A; also feed rocker shaft collar for Styles 15800 D, 15800 E, 15800 G.....	19

LIST OF PARTS

Symbol to Order by	The figures in the last column refer only to the plates illustrating the parts, and are not to be used in ordering. Refer to pink insert for prices.	Plate No.
Y502-319	Expansion Reamer, for presser bar and presser guide bar size .319 inch.....	29
Y502-322	Expansion Reamer, size .322 inch.....	—
Y502-325	Expansion Reamer, size .325 inch.....	—
Y502-328	Expansion Reamer, size .328 inch.....	—
Y505-407	Expansion Reamer, for feed rocker shafts and feed bar shaft, size .407 inch.....	29
Y505-410	Expansion Reamer, size .410 inch.....	—
Y505-413	Expansion Reamer, size, .413 inch.....	—
Y505-416	Expansion Reamer, size .416 inch.....	—
Y506-530	Expansion Reamer, for main shafts, size .530 inch.....	29
Y506-533	Expansion Reamer, size .533 inch.....	—
Y506-536	Expansion Reamer, size .536 inch.....	—
Y510-200	Expansion Reamer, for needle bars, size .200 inch.....	—
531	Set Screw, for binder swinging arm support.....	5
540	Frame Thread Eyelet Guide Pin.....	15
604	Screw, for presser foot extension on No. 15820 D.....	5
605	Screw, for yielding side spring Nos. 15882, 15882 A 19146 A; also for No. 15930 A.....	5
605 A	Screw, for needle bar thread eyelet.....	5
727	Looper, with guard for Styles 15800 D, 15800 E, 15800 G.....	2
727 A	Looper, without guard, otherwise same as No. 727.....	2
	Looper Set Screw No. 22565.	
729	Looper Needle Guard, marked "Q", for loopers Nos. 727, 15807, 15907.....	12
	Looper Needle Guard Screw No. 73 A.	
Y800	Taper Reamer, for lever end of needle lever stud.....	—
Y801	Taper Reamer, for frame end of needle lever stud.....	—
Y802	Taper Reamer, for needle bar link pins and feed crank link pins.....	29
892	Upper Knife Bar Shaft, for Styles 13200 A, 15800 A, 15800 B.....	20
‡1230 A	Needle Lever Connection Upper Bearing.....	22
	Needle Lever Connection Upper Bearing Screws No. 22587.	
1230 B	Needle Lever Connection Bearing Valve Spring.....	9
	Needle Lever Connection Bearing Valve Spring Screw No. 22586 A.	
1230 C	Needle Lever Connection Tube.....	19
	Needle Lever Connection Tube Nut, left thread, No. 15430 C.	
	Needle Lever Connection Tube Nut, right thread, No. 15430 D.	
1230 D	Needle Lever Connection Bearing Valve.....	7
1275 A	Needle Lever Stud, standard diameter.....	25

‡ See page 25.

LIST OF PARTS

Symbol to Order by	The figures in the last column refer only to the plates illustrating the parts, and are not to be used in ordering. Refer to pink insert for prices.	Plate No.
1275 E	Needle Lever Stud, plus size on frame section, viz.; .001, .002, .003, .006, .012, .018 inch; specify plus amount. Example; 1275 E-003 represents a stud plus .003 inch on frame section.....	—
1275 F	Needle Lever Stud, plus size on lever section, viz.; .001, .002, .003, .006 inch; specify plus amount. Example; 1275 F-003 represents a stud .003 inch on lever section..	—
1275 H	Needle Lever Stud, plus size equal on each section; viz.; .001, .002, .003, .006 inch; specify plus amount. Example; 1275 H-003 represents a stud plus .003 inch on each section.....	—
1275 J	Needle Lever Stud, plus size unequal on each section, viz. (.001, .002) (.001, .003) (.001, .006) (.002, .001) (.002, .003) (.002, .006) (.003, .001) (.003, .002) (.003, .006) (.006, .001) (.006, .002) (.006, .003) (.012, .001) (.012, .002) (.012, .003) (.012, .006) (.018, .001) (.018, .002) (.018, .003) (.018, .006) Specify plus amounts, arranged frame section first and lever section last. Examples; 1275 J-003-006 represents a stud plus .003 inch on frame section and .006 inch on lever section, 1275 J-006-003 represents a stud plus .006 inch on frame section and .003 inch on lever section .	—
	Needle Lever Stud Screw No. 22586.	
	Needle Lever Stud Felt No. 15430 L. Note: Before lapping the bearing of a needle lever and a needle lever stud remove the felt from the stud and replace it after the lapping compound has been washed out.	
1286	Needle Lever Link Pin Assembly, internal oiling, hardened and ground, includes one each Nos. 1286 A, 1286 B, 12964 C, 22560; also for Nos. 15446 D, 15872 B.	8
1286 A	Needle Lever Link Pin.....	8
	Needle Lever Link Pin Set Screw, upper, No. 77.	
	Needle Lever Link Pin Set Screw, lower, No. 78.	
	Needle Lever Link Pin Ball No. 12964 C.	
1286 B	Needle Lever Link Pin Ball Spring.....	9
	Needle Lever Link Pin Ball Spring Screw No. 22560.	
1346	Tension Post, length over all $1\frac{1}{8}$ inches, for style 13200 A..	7
1347	Tension Post Ferrule, hardened, length over all $\frac{5}{8}$ inch, for Style 13200 A.....	8
1349 A-0	Tension Spring, .016 inch diameter wire, for looper thread, on styles in Classes 13200, 15800.....	9
1349 A-3	Tension Spring, .028 inch diameter wire, for looper thread, on styles in Class 15900; also for needle thread on Styles 15800 D, 15800 E, 15800 G.....	9

LIST OF PARTS

Symbol to Order by	The figures in the last column refer only to the plates illustrating the parts, and are not to be used in ordering. Refer to pink insert for prices.	Plate No.
1349 A-4	Tension Spring, .036 inch diameter wire, for needle thread on styles in Classes 13200, 15900; also for Styles 15800 A, 15800 B	9
1361 A	Presser Spring Pin, length over all $\frac{3}{8}$ inch	15
1362	Main Shaft Sleeve Pin, length over all $1\frac{1}{2}$ inches	15
1588	Cloth Plate Swinging Extension Spring Latch, for Style 15800 D	9
	Cloth Plate Swinging Extension Spring Latch Screw No. 22564 A.	
2306	Feed Lift Eccentric, ground, for Styles 15800 E, 15800 G..	22
	Feed Lift Eccentric Screw No. 96.	
2324 Q	Throat Plate, for Style 15800 G	2
	Throat Plate Screw No. 87.	
2327	Presser Foot, for Style 15800 G	3
	Presser Foot Screw No. 91.	
2333	Feed Bar Prong and Sponge, for Styles 15800 D, 15800 E, 15800 G	23
	Feed Bar Prong Screws No. 94.	
2334	Differential Feed Bar Link, for Styles 15800 D, 15800 E, 15800 G	13
	Differential Feed Bar Link Screws No. 97.	
2335	Differential Feed Bar, for Styles 15800 D, 15800 E, 15800 G	23
2338	Main Shaft Sleeve, $1\frac{1}{4}$ inches long, for styles in Class 15900; also for Styles 15800 D, 15800 E, 15800 G	8
4517	Needle Bar, hardened and ground, for styles in Class 15900; also for Styles 15800 A, 15800 B	20
5125	Feed Bar Needle Rear Guard, hardened, marked "AJ" for Style 15800 A	1
	Feed Bar Needle Rear Guard Screw No. 94.	
5142	Feed Bar, for Styles 13200 A, 15800 A	26
	Feed Bar Screws No. 88.	
5143	Differential Feed Bar, for Style 15800 B	26
5144	Differential Feed Bar Link Stud Nut	8
5156	Feed Rocker, for Style 15800 B	27
	Feed Rocker Screws No. 88.	
5157	Feed Rocker Connection	27
	Feed Rocker Connection Screws No. 22548.	
6038	Looper Connecting Rod Ball Joint Assembly, left	22
6039	Looper Connecting Rod Ball Joint Assembly, right	22
	Looper Connecting Rod Ball Joint Screws No. 97 A.	
	Looper Connecting Rod Ball Stud Nut No. 18.	
6427 J	Presser Foot, for Style 15900 E	3
6520	Presser Foot, for Style 15900 A	3
	Presser Foot Clamp Screw No. 91.	

LIST OF PARTS

Symbol to Order by	The figures in the last column refer only to the plates illustrating the parts, and are not to be used in ordering. Refer to pink insert for prices.	Plate No.
7945	Looper Rocker Cone.....	13
	Looper Rocker Cone Screws No. 77.	
9224 E	Throat Plate, for Style 15900 A.....	2
	Throat Plate Screws No. 87.	
9932	Feed Bar Shoe, for styles in Classes 13200, 15900; also for Styles 15800 A, 15800 D, 15800 E, 15800 G.....	16
	Feed Bar Shoe Screw No. 94.	
11261 A	Tension Post, length over all $1\frac{1}{8}$ inches. Obsolete—Re- placed by Nos. 1346, 1347, 13148 A-20 and 35582 B...	7
11261 B	Tension Post Ferrule, length over all $\frac{3}{16}$ inch. Obsolete— Replaced by Nos. 1347, 1346, 13148 A-20 and 35582 B...	8
11354	Looper Eccentric Connection Ball, hardened.....	7
11755	Hand Lifter, for style 15900 D.....	19
	Hand Lifter Stud No. 86.	
12865	Presser Spring Rest Support Collar.....	8
12934 A	Looper Eccentric Connection Ball Stud Nut; also for No. 23322 S.....	8
12954	Tension Thread Eyelet, one eye, $1\frac{1}{8}$ inches long. Obso- lete—Replaced by No. 336.....	10
12957 E	Binder Swinging Arm Stud Spring Washer.....	15
12964 C	Needle Lever Link Pin Ball.....	15
12982	Knife Bar Locking Handle Nut, for Styles 13200 A, 15800 A, 15800 B.....	8
12982 A	Knife Bar Locking Bolt Threaded Bushing, for Styles 13200 A, 15800 A, 15800 B.....	7
12983	Knife Bar Locking Handle.....	13
	Knife Bar Locking Handle Screw No. 77.	
12984	Knife Bar Locking Handle Stop Pin, for Styles 13200 A, 15800 A, 15800 B.....	15
12986 B	Screw, for binding guard on Styles 13200 A, 15800 A, 15800 B.....	5
13148 A-20	Tension Post Elongating Stud, $\frac{5}{8}$ inch increment, for styles in Class 13200.....	6
13205	Feed Dog, for Style 13200 A.....	4
	Feed Dog Screw No. 93 A.	
13214	Looper Eccentric, hardened and ground, for Style 13200 A Looper Eccentric Screw No. 96.	22
13217-2	Needle Bar, hardened and ground, for No. 2 gauge, Style 13200 A.....	20
13217-4	Needle Bar, hardened and ground, for No. 4 gauge, Style 13200 A.....	20
	Needle Bar Set Screws No. 88.	
13218-2	Needle Clamp Collar, for No. 2 gauge, Style 13200 A.....	8

LIST OF PARTS

Symbol to Order by	The figures in the last column refer only to the plates illustrating the parts, and are not to be used in ordering. Refer to pink insert for prices.	Plate No.
13218-4	Needle Clamp Collar, for No. 4 gauge, Style 13200 A Needle Clamp Collar Screw No. 89. Needle Set Screw No. 88 B.	8
13220-2	Presser Foot, for No. 2 gauge, Style 13200 A Presser Foot Clamp Screw No. 91. Presser Foot Yielding Side Spring No. 19146 A. Presser Foot Yielding Side Spring Screw No. 605.	3
13220 A-4	Presser Foot, for No. 4 gauge, Style 13200 A Presser Foot Clamp Screw No. 91. Presser Foot Yielding Side Spring No. 15882. Presser Foot Yielding Side Spring Screw No. 605.	3
13224 A-2	Throat Plate, for No. 2 gauge, Style 13200 A	2
13224 A-4	Throat Plate, for No. 4 gauge, Style 13200 A Throat Plate Screws No. 87.	2
13225	Feed Bar Needle Rear Guard, for Style 13200 A Feed Bar Needle Rear Guard Screw No. 94.	1
13254	Take-up Thread Eyelet, for looper thread of Style 13200 A Take-up Thread Eyelet Screw No. 90.	10
14076	Stud, for take-up thread eyelet holder	6
14544	Differential Feed Bar Shaft, hardened and ground, $3\frac{9}{16}$ inches long for Styles 15800 B, 15800 D, 15800 E 15800 G	11
15421	Pulley Pulley Screws No. 22597.	25
15430 C	Needle Lever Connection Tube Nut, left thread	8
15430 D	Needle Lever Connection Tube Nut, right thread	8
15430 L	Needle Lever Connection Oil Retaining Felt; also for Nos. 1275 A, 1275 E, 1275 F, 1275 H, 1275 J	19
†15430 M	Needle Lever Connection Lower Bearing Needle Lever Connection Lower Bearing Screws No. 22587.	22
15431	Needle Lever Washer, wood fibre	14
15432	Needle Lever Ball, hardened	7
15433	Needle Lever Ball Nut	8
15434	Needle Lever Eccentric and Balance Weight, formerly marked "BM", for styles in Class 15900; also for 13200 A, 15800 A, 15800 B, 15800 E, 15800 G Needle Lever Eccentric Spot Screw No. 81. Needle Lever Eccentric Set Screw No. 95.	22
15435 G	Frame Needle Thread Controller Guide, adjustable for styles in Class 15800 Frame Needle Thread Controller Guide Screw No. 94.	10
15435 M	Balance Weight Guard, for use with thread eyelet No. 15435 N. Obsolete	16

† See page 25.

LIST OF PARTS

Symbol to Order by	The figures in the last column refer only to the plates illustrating the parts, and are not to be used in ordering. Refer to pink insert for prices.	Plate No.
15435 N	Balance Weight Guard Thread Eyelet, for Style 13200. Obsolete.....	10
15435 P	Balance Weight Guard Thread Eyelet Screw No. 73 A. Balance Weight Guard Thread Eyelet Support, for Style 13200. Obsolete.....	15
15436	Balance Weight Guard Thread Eyelet Support Screws No. 73 A.	
15437 A	Renewable Bearing, for needle bar..... Renewable Bearing Clamp Screw No. 22569.	8
15438 B	Needle Bar Connection Assembly, one each Nos. 15438 C, 15438 D, 15438 H, 15438 J, and two No. 15438 B.....	13
15438 C	Needle Bar Thread Nipper Disc, hardened.....	12
15438 D	Needle Bar Thread Nipper Disc Spring.....	9
15438 H	Needle Bar Thread Nipper Stud.....	6
15438 J	Needle Bar Connection.....	19
15446 C	Needle Bar Thread Nipper Guide.....	19
15446 D	Differential Feed Bar Link Stud.....	6
15447 F	Differential Feed Bar Link, for Style 15800 B..... Differential Feed Bar Link Screw No. 22743.	13
15447 G	Feed Bar Shoe, hardened and ground, for Style 15800 B.. Feed Bar Shoe Screw No. 93.	14
15447 K	Feed Bar Prong and Sponge, for Style 15800 B..... Feed Bar Prong Screws No. 94.	23
15447 L	Differential Feed Bar Guide, upper, for Style 15800 B.... Differential Feed Bar Guide Screws No. 90.	13
15448	Differential Feed Bar Guide, lower..... Differential Feed Bar Guide Screw, front, No. 93. Differential Feed Bar Guide Screw, rear, No. 94.	13
15448-322	Presser Bar, hardened and ground, standard diameter .319 inch.....	20
15448-325	Presser Bar, standard diameter plus .003 inch.....	—
15448-328	Presser Bar, standard diameter plus .006 inch.....	—
15448-331	Presser Bar, standard diameter plus .009 inch.....	—
15448-334	Presser Bar, standard diameter plus .012 inch.....	—
15451	Presser Bar, standard diameter plus .015 inch.....	—
15453	Lower Knife Clamp, for Styles 13200 A, 15800 A, 15800 B Lower Knife Clamp Screw No. 93.	12
15453 E	Lower Knife Support Adjusting Screw, for Styles 15800 A, 15800 B.....	7
15454	Lower Knife Support Adjusting Screw, for Style 13200 A.. Lower Knife Support Adjusting Screw Plate, for Styles 13200 A, 15800 A, 15800 B.....	7
	Lower Knife Support Adjusting Screw Plate Screws No. 90.	14

LIST OF PARTS

Symbol to Order by	The figures in the last column refer only to the plates illustrating the parts, and are not to be used in ordering. Refer to pink insert for prices.	Plate No.
15458	Front Cover Support, for No. 15857..... Front Cover Support Screws No. 90.	18
15458 A	Front Cover Hinge Pin, for No. 15857.....	25
15458 D	Front Cover Diverting Guide Spring, for No. 15857.....	9
15458 F	Front Cover Diverting Guide Spring Plate, for No. 15857 Front Cover Diverting Guide Spring Plate Screws No. 22561.	15
15458 H	Front Cover Locking Pin, for No. 15857.....	15
15458 J	Front Cover Locking Pin Spring, for Styles 13200 A, 15800 A, 15800 B.....	9
15458 M	Front Cover Diverting Guide Handle Latch, for No. 15857.....	13
15459	Presser Spring.....	25
15481	Knife Bar Locking Bolt, for Styles 13200 A, 15800 A, 15800 B.....	7
15491 A	Looper Frame Thread Eyelet. Obsolete.....	19
15492	Tension Post, length over all 2 $\frac{3}{4}$ inches.....	7
15493 A	Frame Looper Thread Eyelet, for Style 13200 A..... Looper Frame Thread Guide Screw No. 94.	10
15496 B	Frame Looper Thread Guide..... Frame Looper Thread Guide Screw No. 98 A.	25
15498 E	Grinder Head, for knife grinders.....	21
15498 G	Grinder Swinging Frame Pivot Pin, hardened and ground	20
15498 H	Grinder Swinging Frame Pivot Pin Friction Washer..... Grinder Swinging Frame Pivot Pin Friction Washer Screw No. 93 A.	15
15498 J	Grinder Swinging Frame Adjusting Sleeve..... Grinder Swinging Frame Adjusting Sleeve Clamp Screw No. 136. Grinder Swinging Frame Adjusting Sleeve Stop Screw No. 81.	21
15498 K	Grinder Swinging Frame Adjusting Thumb Screw.....	21
15498 L	Grinder Swinging Frame Stop Pin..... Grinder Swinging Frame Stop Pin Regulating Screw No. 64 A.	19
15498 N	Grinder Knife Positioning Lever..... Grinder Knife Positioning Lever Screw No. 86.	14
15498 P	Grinder Dust Guard..... Grinder Dust Guard Screw No. 22570.	21
15498 V	Grinder Swinging Frame Top Plate, for No. 15898 B..... Grinder Swinging Frame Top Plate Screws No. 22516.	14
15595 A	Thread Controller Rack, for styles in Class 13200, 15900.. Thread Controller Rack Screw No. 22519.	13
15595 B	Thread Controller Thread Guide.....	10

LIST OF PARTS

Symbol to Order by	The figures in the last column refer only to the plates illustrating the parts, and are not to be used in ordering. Refer to pink insert for prices.	Plate No.
15595 F	Needle Lever Thread Guide, for styles in Class 13200, 15900.....	10
	Needle Lever Thread Guide Screw No. 98 A.	
15724 E	Throat Plate, for use in conjunction with main feed dog sections Nos. 15805 D or 15805 J and 15826 A for mak- ing $\frac{1}{8}$ inch minimum width of seam on Style 15800 D...	1
15801 C	Cloth Plate, for Styles 13200 A, 15800 A, 15800 B.....	30
† 15801 H	Cloth Plate Assembly, for Style 15800 D.....	30
‡ 15801 K	Cloth Plate Assembly, for Styles 15800 E, 15800 G.....	30
	Cloth Plate Screws No. 22574.	
15802	Cloth Plate Cover, for Styles 15800 D, 15800 E, 15800 G..	18
	Cloth Plate Cover Screws No. 87.	
15805 D	Main Feed Dog, for use with throat plate No. 15724 E...	4
15805 E	Main Feed Dog, for Styles 15800 E, 15800 G.....	4
	Main Feed Dog Screw No. 22585.	
15805 F	Feed Dog, for Style 15800 A.....	4
	Feed Dog Screw No. 93 A.	
15805 G	Main Feed Dog, for Style 15800 B.....	4
	Main Feed Dog Screws No. 22593.	
15805 J	Main Feed Dog Section, comprising two rows of teeth cut 8 to the inch and shank, for Style 15800 D.....	4
	Main Feed Dog Section Screw No. 22585.	
15805 K	Main Feed Dog Section, comprising one row of teeth cut 22 to inch, for Style 15800 D.....	4
	Main Feed Dog Section Screw No. 22716.	
15806	Feed Lift Eccentric, ground, marked "DH", for Style 15800 D.....	22
	Feed Lift Eccentric Screw No. 96.	
15807	Looper, with guard and closed rear thread eye. Obsolete..	—
15807 D	Looper, with guard and closed rear thread eye. Obsolete..	—
	Looper Set Screw No. 22565.	
15814	Looper Eccentric, hardened, formerly marked "C V", for styles in Classes 15800 and 15900.....	22
	Looper Eccentric Screw No. 96.	
15815	Needle Lever, for Styles 15800 A, 15800 B, 15800 E, 15800 G.....	28
15815 D	Needle Lever, for Style 15800 D.....	28
15817	Needle Bar, for Styles 15800 D, 15800 E, 15800 G.....	20
	Needle Bar Set Screws No. 88.	
15820 D	Presser Foot for Style 15800 D.....	3
	Presser Foot Extension No. 15881 B.	
	Presser Foot Extension Screw No. 604.	
	Presser Foot Clamp Screw No. 91.	

† See page 25.

LIST OF PARTS

Symbol to Order by	The figures in the last column refer only to the plates illustrating the parts, and are not to be used in ordering. Refer to pink insert for prices.	Plate No.
15820 E	Presser Foot, for Style 15800 E.	3
	Presser Foot Extension No. 15881 D.	
	Presser Foot Extension Screw No. 91 A.	
	Presser Foot Clamp Screw No. 91.	
15820 F	Presser Foot, for Styles 15800 A, 15800 B.	3
	Presser Foot Extension No. 15881 A.	
	Presser Foot Extension Screw No. 187 A.	
	Presser Foot Yielding Side No. 15820 FA.	
	Presser Foot Yielding Side Spring No. 15882.	
	Presser Foot Yielding Side Spring Screw No. 605.	
	Presser Foot Clamp Screw No. 22765.	
15820 FA	Yielding Side, for Presser Foot No. 15820 F.	3
15822	Main Shaft, hardened and ground, for styles in Classes 13200, 15900; also for Style 15800 A, 15800 B, standard diameter .530 inch.	28
15822-531	Main Shaft, standard diameter plus .001 inch.	—
15822-533	Main Shaft, standard diameter plus .003 inch.	—
15822-536	Main Shaft, standard diameter plus .006 inch.	—
15822-539	Main Shaft, standard diameter plus .009 inch.	—
15822 A	Main Shaft, hardened and ground, for Styles 15800 D, 15800 E, 15800 G, standard diameter .530 inch.	28
15822 A-531	Main Shaft, standard diameter plus .001 inch.	—
15822 A-533	Main Shaft, standard diameter plus .003 inch.	—
15822 A-536	Main Shaft, standard diameter plus .006 inch.	—
15822 A-539	Main Shaft, standard diameter plus .009 inch.	—
15824 C	Throat Plate, for Styles 15800 A, 15800 B.	1
	Throat Plate Screws No. 87.	
15824 D	Throat Plate, for Style 15800 D.	1
15824 E	Throat Plate, for Style 15800 E.	2
	Throat Plate Screws No. 87.	
15824 G	Throat Plate, minimum width of seam $\frac{7}{32}$ inch, for Style 15800 D.	1
15824 H	Throat Plate, minimum width of seam $\frac{3}{16}$ inch, for Style 15800 D.	1
15825	Feed Bar Needle Rear Guard, marked "CK", for Style 15800 B.	1
	Feed Bar Needle Rear Guard Screw No. 77 A.	
15825 A	Needle Rear Guard, marked "CU", for Styles 15800 D, 15800 E, 15800 G.	1
	Needle Rear Guard Screw No. 22585.	
15826 A	Main Feed Dog Section, 22 teeth to inch, for use with throat Plate No. 15724 E.	4
15826 D	Differential Feed Dog, for Style 15800 D.	4
15826 E	Differential Feed Dog, for Styles 15800 E, 15800 G.	4

LIST OF PARTS

Symbol to Order by	The figures in the last column refer only to the plates illustrating the parts, and are not to be used in ordering. Refer to pink insert for prices.	Plate No.
15826 G	Differential Feed Dog, for Style 15800 B.	4
15827 C	Differential Feed Dog Screw No. 22585, Presser Foot, solid, $\frac{1}{2}$ inch wide, with non-adjustable paring guard, for Style 15800 D.	3
15827 D	Presser Foot, with independently yielding needle hole section, for Style 15800 D.	3
	Presser Foot Yielding Section Spring No. 15882 A. Presser Foot Yielding Section Spring Screw No. 605. Presser Foot Yielding Section Plate Screws No. 22716. Presser Foot Clamp Screw No. 91.	
15831 C	Feed Rocker, for Styles 15800 D, 15800 E and 15800 G. . .	27
	Feed Rocker Screws No. 88.	
15834	Needle Lever Eccentric and Balance Weight, formerly marked "DJ", for Style 15800 D.	22
	Needle Lever Eccentric Spot Screw No. 81. Needle Lever Eccentric Set Screw No. 95.	
15835	Balance Weight Guard, for styles in Classes 13200, 15900; also for Styles 15800 A, 15800 B.	16
	Balance Weight Guard Screws No. 93 A.	
15835 A	Balance Weight Guard, front, for Styles 15800 D, 15800 E, 15800 G.	16
	Balance Weight Guard Screws No. 93 A.	
15835 B	Balance Weight Guard, rear, for Styles 15800 D, 15800 E, 15800 G.	16
	Balance Weight Guard Screws No. 94.	
15835 C	Looper Thread Pull-off Thread Guide, for Styles 15800 D, 15800 E, 15800 G.	10
	Looper Thread Pull-off Thread Guide Screw No. 187 A.	
15835 D	Looper Thread Pull-off, for Styles 15800 D, 15800 E, 15800 G.	10
15838 A	Differential Feed Bar Guiding Yoke, for Styles 15800 D, 15800 E, 15800 G.	19
	Differential Feed Bar Guiding Yoke Screws No. 94.	
15839 A	Differential Feed Bar Link Screw Pin, for Styles 15800 D, 15800 E, 15800 G.	6
15847	Main Feed Bar, for Style 15800 B.	23
	Main Feed Bar Screws No. 88.	
15847 A	Feed Bar Needle Rear Guard Holder, for Style 15800 B. . .	12
	Feed Bar Needle Guard Holder Screw No. 77 A	
15847 C	Main Feed Dog Holder, for Style 15800 B.	12
	Main Feed Dog Holder Screw No. 93 A.	
15847 E	Main Feed Bar, for Styles 15800 D, 15800 E, 15800 G. . . .	23
	Main Feed Bar Screws No. 88.	
15849 A	Lower Knife, for Styles 13200 A, 15800 A, 15800 B.	11

LIST OF PARTS

Symbol to Order by	The figures in the last column refer only to the plates illustrating the parts, and are not to be used in ordering. Refer to pink insert for prices.	Plate No.
15849 D	Lower Knife, .054 inch thick, for Styles 15800 D, 15800 E, 15800 G.....	11
15849 E	Lower Knife, .100 inch thick, for Style 15800 D.....	11
15850	Lower Knife Support, for Styles 13200 A, 15800 A, 15800 B Lower Knife Support Screw No. 22548.	16
15850 B	Lower Knife Support, for Styles 15800 D, 15800 E, 15800 G Lower Knife Support Screws No. 136.	23
15851 B	Lower Knife Clamp, for Styles 15800 D, 15800 E, 15800 G. Lower Knife Clamp Screw No. 22790. Lower Knife Clamp Screw Nut No. T14.	12
15852	Lower Knife Support Adjusting Screw, for Styles 15800 D, 15800 E, 15800 G.....	7
15852 A	Lower Knife Support Adjusting Screw Plate..... Lower Knife Support Adjusting Screw Plate Screw No. 22585.	12
15852 B	Lower Knife Support Adjusting Screw Bracket..... Lower Knife Support Adjusting Screw Bracket Screws No. 22596.	14
15854 A	Take-up Thread Eyelet, for looper thread on styles in Classes 15800, 15900.....	10
	Take-up Thread Eyelet Screw No. 90.	
15854 B	Take-up Thread Eyelet Holder..... Take-up Thread Eyelet Holder Pivot Stud No. 14076. Take-up Thread Eyelet Holder Stop Screw No. 22575. Take-up Thread Eyelet Holder Stop Screw Nut No. 41071 G.	16
15855 A	Take-up Thread Eyelet Spring..... Take-up Thread Eyelet Spring Screws No. 93 A.	25
15857	Front Cover Assembly..... Front Cover Screws No. 90.	—
15858 B	Front Cover Diverting Guide, for parings.....	18
15858 C	Front Cover Diverting Guide Support.....	18
15858 L	Front Cover Diverting Guide Handle..... Front Cover Diverting Guide Handle Screws No. 22561.	13
15858 M	Knife Guard, for Style 15800 D..... Knife Guard Screws No. 187 A.	18
15858 N	Knife Guard, for Styles 15800 E, 15800 G..... Knife Guard Screws No. 187 A.	18
15860	Looper Thread Nipper Spring Operating Arm..... Looper Thread Nipper Spring Operating Arm Screw No. 97.	13
15862	Looper Rocker Swinging Support..... Looper Rocker Swinging Support Screws No. 88.	24
15863	Looper Rock Shaft Frame..... Looper Rock Shaft Frame Screws No. 136.	23

LIST OF PARTS

Symbol to Order by	The figures in the last column refer only to the plates illustrating the parts, and are not to be used in ordering. Refer to pink insert for prices.	Plate No.
15864	Looper Connecting Rod, length over all $5\frac{11}{16}$ inches..... Looper Connecting Rod Nut, left thread, No. 269. Looper Connecting Rod Nut, right thread, No. 18.	20
15865	Looper Eccentric Connection..... Looper Eccentric Connection Screws, upper, No. 97 A. Looper Eccentric Connection Screws, lower, No. 75 A.	22
15866	Binding Guard Assembly, for Styles 13200 A, 15800 A, 15800 B..... Binding Guard Screw No. 12986 B.	18
15866 A	Binding Guard Support, for No. 15866.....	—
15866 B	Binding Guard, for No. 15866.....	—
15866 C	Spring, for No. 15866.....	9
15866 D	Hinge Pin, for No. 15866.....	—
15867 A	Binding Cutter Assembly, for Styles 15800 A, 15800 B...	—
15867 B	Upper Knife, for No. 15867 A..... Upper Knife Screw No. 223 C.	11
15867 C	Upper Knife Spring Washer, for No. 15867 A.....	15
15867 D	Lower Knife, for No. 15867 A..... Lower Knife Screw No. 134.	11
15867 E	Lower Knife Spring, for No. 15867 A.....	9
15867 F	Knife Support, for No. 15867 A..... Knife Support Screws No. 91.	16
15867 G	Knife Support Bracket, for No. 15867 A..... Knife Support Bracket Screw No. 22572.	13
15868 A	Cloth Plate Swinging Extension, for Styles 13200 A, 15800 A, 15800 B..... Cloth Plate Swinging Extension Screw No. 86.	24
15870 A	Upper Knife, for Styles 13200 A, 15800 A, 15800 B..... Upper Knife Clamping Screw No. 22572 A.	11
15870 D	Upper Knife, for Styles 15800 D, 15800 E, 15800 G..... Upper Knife Clamping Screw No. 75.	11
15871	Upper Knife Bar, for Styles 13200 A, 15800 A, 15800 B... Upper Knife Bar Screws No. 22572.	23
15871 D	Upper Knife Bar, for Styles 15800 D, 15800 E, 15800 G... Upper Knife Bar Screw No. 93.	23
15872	Upper Knife Bar Adjusting Threaded Sleeve, for Styles 13200 A, 15800 A, 15800 B.....	7
15872 A	Upper Knife Bar Carrier, for Styles 15800 D, 15800 E, 15800 G.....	23
15872 B	Upper Knife Bar Carrier Link..... Upper Knife Bar Carrier Link Clamp Screw No. 97. Upper Knife Bar Carrier Link Pin Set Screw No. 22743.	19
15872 C	Upper Knife Bar Carrier Link Ferrule hardened and ground.....	8
15872 D	Upper Knife Bar Carrier Link Ferrule Stud.....	6

LIST OF PARTS

Symbol to Order by	The figures in the last column refer only to the plates illustrating the parts, and are not to be used in ordering. Refer to pink insert for prices.	Plate No.
15872 E	Upper Knife Bar Lifting Lever, for Styles 15800 D, 15800 E, 15800 G.....	24
15872 F	Upper Knife Bar Lifting Lever Spring.....	9
15872 G	Upper Knife Bar Locking Lever, for Styles 15800 D, 15800 E, 15800 G.....	24
	Upper Knife Bar Locking Lever Screw No. 93.	
15872 H	Upper Knife Bar Locking Lever Plunger.....	7
	Upper Knife Bar Locking Lever Plunger Nut No. 21185.	
15872 J	Upper Knife Bar Locking Lever Plunger Spring.....	9
15872 K	Upper Knife Bar Carrier Shaft, round, for Styles 15800 D, 15800 E, 15800 G.....	20
	Upper Knife Bar Carrier Shaft Spot Screw No. 89.	
15872 L	Upper Knife Bar Carrier Shaft, slabbed.....	15
15873	Upper Knife Bar Shaft Bearing, for Styles 13200 A, 15800 A, 15800 B. Note: This part is only furnished when repairs are made at the factory.....	—
	Upper Knife Bar Shaft Bearing Screws No. 136.	
15873 A	Upper Knife Bar Shaft Bearing, for Styles 15800 D, 15800 E, 15800 G.....	23
	Upper Knife Bar Shaft Bearing Screws No. 136.	
15874	Upper Knife Bar Shaft Locking Lever, for Styles 13200 A, 15800 A, 15800 B.....	16
	Upper Knife Bar Shaft Locking Lever Screw No. 93.	
15875	Upper Knife Bar Shaft Locking Lever Block.....	14
	Upper Knife Bar Shaft Locking Lever Block Screw No. 22574.	
15876	Upper Knife Spring Chamber, for Styles 13200 A, 15800 A, 15800 B.....	24
	Upper Knife Spring Chamber Screw No. 93.	
15877	Upper Knife Spring.....	9
15877 A	Upper Knife Spring Retaining Collar.....	19
15878	Knife Eccentric, marked "CU", for Styles 13200 A, 15800 A, 15800 B.....	22
	Knife Eccentric Set Screw No. 95.	
	Knife Eccentric Spot Screw No. 96.	
15878 D	Knife Eccentric marked "DG", for Style 15800 D.....	22
	Knife Eccentric Set Screw No. 95.	
15878 E	Knife Eccentric marked "DK", for Style 15800 E, 15800 G	22
	Knife Eccentric Set Screw No. 95.	
15879	Knife Eccentric Connection, for Styles 13200 A, 15800 A, 15800 B.....	22
15879 A	Knife Eccentric Connection, for Styles 15800 D, 15800 E, 15800 G.....	22
	Knife Eccentric Connection Screws No. 75 A.	

LIST OF PARTS

Symbol to Order by	The figures in the last column refer only to the plates illustrating the parts, and are not to be used in ordering. Refer to pink insert for prices.	Plate No.
15879 E	Upper Knife Lever Ball.....	7
	Upper Knife Lever Ball Nut No. 258.	
15880	Upper Knife Lever, for Styles 13200 A, 15800 A, 15800 B..	23
15880 A	Upper Knife Lever, for Styles 15800 D, 15800 E, 15800 G..	24
	Upper Knife Lever Clamp Screw No. 93.	
	Upper Knife Lever Spot Screw No. 96.	
15880 B	Knife Rock Shaft, for Styles 15800 D, 15800 E, 15800 G..	20
15881 A	Presser Foot Extension, for No. 15820 F.....	12
	Presser Foot Extension Screw No. 187 A.	
15881 B	Presser Foot Extension, for No. 15820 D.....	12
	Presser Foot Extension Screw No. 604.	
15881 D	Presser Foot Extension, for No. 15820 E.....	12
	Presser Foot Extension Screw No. 91 A.	
15882	Yielding Side Spring, for presser feet Nos. 13220 A-4, 15820 F.....	9
	Yielding Side Spring Screw No. 605.	
15882 A	Yielding Section Spring, for presser foot No. 15827 D.....	9
	Yielding Section Spring Screw No. 605.	
	Yielding Section Spring Plate Screws No. 22716.	
15883	Knife Guard, for presser feet Nos. 15820 D, 15820 E....	12
	Knife Guard Screw No. 91 A.	
15885	Knife Rock Shaft Oil Guard, for Styles 13200 A, 15800 A, 15800 B.....	16
	Knife Rock Shaft Oil Guard Screw No. 22561.	
15886	Main Shaft Sleeve, $\frac{7}{8}$ inch long.....	8
15887	Looper Rocker Stud Nut.....	8
15898 B	Knife Grinder, for knives Nos. 15849 A and 15870 A.....	—
15898 C	Knife Grinder Swinging Frame, for No. 15898 B.....	21
	Knife Grinder Swinging Frame Set Screws No. 22591.	
15898 D	Knife Grinder, for knives Nos. 15849 D, 15849 E, 15870 D.....	—
15898 E	Grinder Swinging Frame, for No. 15898 D.....	21
	Grinder Swinging Frame Set Screws No. 22591.	
15898 F	Grinder Swinging Frame Top Plate, for No. 15898 D.....	14
	Grinder Swinging Frame Top Plate Screws No. 22516.	
15901	Cloth Plate, for styles in Class 15900.....	30
15904	Cast-off Wire.....	11
	Cast-off Wire Screw No. 87.	
15905 A	Feed Dog, for Style 15900 A.....	4
15905 D	Feed Dog, for Styles 15900 D, 15900 E.....	4
	Feed Dog Screw No. 93.	
15907	Looper, with guard, for styles in Class 15900; also for Styles 15800 A, 15800 B.....	2
	Looper Needle Guard No. 729.	
	Looper Needle Guard Screw No. 73 A.	

LIST OF PARTS

Symbol to Order by	The figures in the last column refer only to the plates illustrating the parts, and are not to be used in ordering. Refer to pink insert for prices.	Plate No.
15908	Looper, without guard, otherwise same as No. 15907..... Looper Set Screw No. 22565.	—
15915	Needle Lever, for styles in Classes 13200, 15900.....	28
15920 D	Presser Foot, for Style 15900 D.....	3
	Presser Foot Clamp Screw No. 91.	
15924 D	Throat Plate, for Style 15900 D.....	2
	Throat Plate Screws No. 87.	
15930	Cloth Plate Slide, left, for Styles 15900 D and 15900 E...	17
15930 A	Cloth Plate Slide Supplemental Plate.....	17
	Cloth Plate Slide Supplemental Plate Screws No. 605.	
15935 A	Cloth Plate Guard, for Style 15900 A.....	27
	Cloth Plate Guard Screws No. 25 C.	
15935 D	Cloth Plate Guard and Binder Support, for Style 15900 D.	27
15935 F	Cloth Plate Guard, for Style 15900 E.....	27
	Cloth Plate Guard Screws No. 25 C.	
15935 G	Projection, for No. 15935 F.....	14
	Projection Screw No. 22561	
15953	Cast-off Wire Bracket.....	14
	Cast-off Wire Bracket Screw No. 93.	
‡15995	Needle Thread Controller Lever Assembly.....	25
19146 A	Yielding Side Spring, for presser foot No. 13220-2.....	9
	Yielding Side Spring Screw No. 605.	
∠21102 D	Thread Stand Base, for Style C stand.....	30
	Thread Stand Base Screws, 32 threads to inch, No. 96.	
	Thread Stand Base Screws, 24 threads to inch, No. 22813.	
∠21104 A	Thread Stand Base, for Style F stand.....	30
	Thread Stand Base Screw No. 22509.	
∠21104 B-9	Thread Stand Horizontal Rod, 9 inches long, for Style F stand.....	30
	Thread Stand Horizontal Rod Set Screw No. 22509.	
∠21104 B-11	Thread Stand Vertical Rod, 11 inches long, for Styles C and F stands.....	30
	Thread Stand Rod Set Screws, 32 threads to inch, for Style C stand, No. 96.	
	Thread Stand Rod Set Screws, 24 threads to inch, for Style C stand, No. 22813.	
	Thread Stand Rod Set Screw, for Style F stand, No. 22509.	
∠21104 C	Thread Stand Rod Connection, for Style F stand.....	24
	Thread Stand Rod Connection Screws No. 22509.	
∠21104 D	Thread Stand Seat, for Style F stand.....	30
∠21104 E	Thread Stand Seat Connection, tiltable, for Style F stand	24
∠21104 F	Thread Stand Seat Pad, felt, for Style F stand.....	30
∠21104 G	Thread Stand Seat Pin, for Style F stand.....	—
∠21104 H	Thread Stand Seat Pin Nut.....	8
∠21104 J	Thread Stand Wire Thread Guide, for Style F stand.....	9

‡ ∠ See page 25.

LIST OF PARTS

Symbol to Order by	The figures in the last column refer only to the plates illustrating the parts, and are not to be used in ordering. Refer to pink insert for prices.	Plate No.
∠21104 K	Thread Stand Wire, 16 inches long, for Style F stand. Thread Stand Wire Set Screw No. 22813.	30
∠21113 A	Thread Stand Wire Extension, 6 inches long. Thread Stand Wire Extension Set Screws, 32 threads to inch, No. 95. Thread Stand Wire Extension Set Screws, 24 threads to inch, No. 22813.	20
∠21113 B	Thread Stand Wire Coupling. Thread Stand Wire Coupling Set Screws No. 88.	8
∠21130 A-2	Thread Stand Seat, Style C, for styles in Classes 15800, 15900.	30
∠21130 A-4	Thread Stand Seat, Style C, for styles in Class 13200. Thread Stand Seat Set Screw No. 69 F D.	30
21145	Wooden Cone, for thread stands.	26
21169 E	Binding Holder Disc.	30
21169 F	Binding Holder Base.	30
21185	Upper Knife Bar Locking Lever Plunger Nut, for Styles 15800 D, 15800 E, 15800 G.	8
21201	Screw Driver, round steel, diameter $\frac{5}{32}$ inch.	29
21202	Screw Driver, round steel, diameter $\frac{7}{32}$ inch, length over all 10 inches.	29
21203	Screw Driver, round steel, diameter $\frac{7}{32}$ inch, length overall 13 inches.	29
21204	Screw Driver, round steel, diameter $\frac{1}{4}$ inch.	29
21205	Screw Driver, octagon steel, diameter $\frac{5}{16}$ inch.	29
21206	Screw Driver Wrench.	29
21207	Screw Driver, round steel, diameter $\frac{5}{64}$ inch.	30
21208	Screw Driver Set, three blades.	30
21210	Looper Collar, .040 inch thick.	—
21210 A	Looper Collar, .020 inch thick.	—
21211	Looper Collar, .054 inch thick.	15
21225- $\frac{7}{32}$	Looper Adjusting Gauge, $\frac{7}{32}$ inch measurement.	14
21261	Leather Belt, flat, 1 inch wide, 63 inches long, including malleable iron belt fastener No. 21350.	—
21262	Leather Belt, round, $\frac{9}{32}$ inch diameter, 44 inches long, including wire belt hook No. 21351.	—
21350	Malleable Iron Belt Fastener, for 1 inch flat belt.	12
21351	Wire Belt Hook, for $\frac{9}{32}$ inch round belt.	12
21355	Chair Leg Extension, 4 inches long.	24
21355 A	Chair Leg Extension, 6 inches long.	24
21355 B	Chair Leg Extension, 3 inches long.	24
21358	Felt Lubricating Section, for main shaft.	12
21371 M	Individual Power Table, excludes pulley guard, pitman, belting, transmitter and electric motor; includes treadle.	—

∠ See page 25

LIST OF PARTS

Symbol to Order by	The figures in the last column refer only to the plates illustrating the parts, and are not to be used in ordering. Refer to pink insert for prices.	Plate No.
21371 T-2	Individual Power Table, includes transmitter, treadles, pulley guard, pitman, belting, $\frac{1}{2}$ H. P. 115 Volt D. C. electric motor. Note: Style of machine must be specified.	—
21371 T-4	Individual Power Table, equipped with $\frac{1}{2}$ H. P. 230 Volt D. C. electric motor.	—
21371 T-6	Individual Power Table, equipped with $\frac{1}{2}$ H. P. 110 Volt, single phase, 60 cycle A. C. electric motor.	—
21371 T-8	Individual Power Table, equipped with $\frac{1}{2}$ H. P. 220 Volt, single phase, 60 cycle A. C. electric motor.	—
21371 T-14	Individual Power Table, equipped with $\frac{1}{2}$ H. P. 110 Volt, three phase, 60 cycle A. C. electric motor.	—
21371 T-16	Individual Power Table, equipped with $\frac{1}{2}$ H. P. 220 Volt, three phase, 60 cycle A. C. electric motor.	—
21375 C	Pulley Guard.	27
21387 D	Supplemental Plate, to raise front of cloth plate level with throat plate, for Style 15900 E.	18
	Supplemental Plate Screws No. 25 C.	
21394	Grinder, including emery wheel, 5 inches diameter, $\frac{1}{4}$ inch face; recommended speed 3,000 revolutions per minute.	—
21394 G	Emery Wheel, 5 inches diameter, $\frac{1}{4}$ inch face, $\frac{3}{8}$ inch hole	—
21394 H	Emery Wheel, 5 inches diameter, $\frac{1}{2}$ inch face, $\frac{3}{8}$ inch hole	—
21394 K	Grinder, including emery wheel, 5 inches diameter, $\frac{1}{2}$ inch face; recommended speed 3,000 revolutions per minute.	—
21680	Iron Base Plate.	30
21681	Machine Bed Screw.	24
22516	Screw, for grinder swinging frame top plates.	6
22519	Screw, for thread controller rack.	6
22521	Screw, plus size, for cloth plates, tap No. V118.	5
22525	Screw, plus size, diameter $\frac{5}{32}$ inch, for throat plates.	5
22526	Screw, plus size, diameter $\frac{3}{16}$ inch, for throat plates, tap No. V109.	5
22539	Screw, for right-hand felt lubricating section chamber.	5
22540	Screw, for middle felt lubricating section chamber.	5
22542	Screw, for looper thread nipper springs.	5
22548	Screw, for lower knife support, on Styles 13200 A, 15800 A, 15800 B.	6
22560	Screw, headless, for needle lever link pin ball spring.	5
22561	Screw, for knife lock shaft oil guard, on Styles 13200 A, 15800 A, 15800 B; also for Nos. 15458 F, 15858 L, 15935 G, 23377 A, 23377 B, 23377 C.	5
22564 A	Screw, for cloth plate extension spring latch No. 380.	5
22565	Set Screw, headless, for loopers.	5
22569	Clamp Screw, for renewable needle bar bearings.	6
22570	Screw, for grinder dust guard.	5

LIST OF PARTS

Symbol to Order by	The figures in the last column refer only to the plates illustrating the parts, and are not to be used in ordering. Refer to pink insert for prices.	Plate No.
22571	Screw, for front cover locking pin spring.....	5
22572	Clamp Screw, for upper knife bar threaded sleeve, also for No. 15867 G.....	6
22572 A	Clamp Screw, for upper knives in Styles 13200 A, 15800 A, 15800 B.....	6
22574	Screw, for cloth plates; also for No. 15875.....	5
22575	Stop Screw, for take-up thread eyelet holder.....	5
22585	Screw, for differential feed dogs; also for Nos. 15805 E, 15805 J, 15825 A, 15852 A.....	5
22586	Screw, headless, for needle lever stud.....	5
22586 A	Screw, for needle lever connection bearing valve spring..	5
22587	Screw, for needle lever connection bearings.....	6
22591	Screw, for knife grinder swinging frame.....	5
22593	Screw, for main feed dog on Style 15800 D.....	6
22596	Screw, for bracket No. 15852 B.....	6
22597	Set Screw, for pulley.....	5
22716	Screw, for main feed dog section No. 15805 K.....	5
22743	Set Screw, for lower needle bar link pin on Styles 15800 D, 15800 E, 15800 G; also for Nos. 15446 D, 15872 B.....	5
22765	Clamp Screw, hexagon head, for presser foot No. 15820 F..	6
22790	Screw, for lower knife clamp in Styles 15800 D, 15800 E, 15800 G.....	5
∠22813	Screw, headless, cup point, $\frac{3}{16}$ inch diameter, 24 threads to inch, for thread stand wire; also for Nos. 21102 D, 21104 B-11, 21113 A.....	5
23322 A	Binder Support, for Styles 13200 A, 15800 A, 15800 B....	14
	Binder Support Screws No. 87 U.	
23322 B	Binder Swinging Arm.....	17
	Binder Swinging Arm Pivot Stud No. 86.	
	Binder Swinging Arm Spring Washer No. 12957 E.	
23322 C	Binder Swinging Arm Support.....	17
	Binder Swinging Arm Support Screw No. 98.	
23322 J- $\frac{3}{4}$	Bias Binder, for Style 15900 D, width of binding, $\frac{3}{4}$ inch..	17
23322 J- $\frac{7}{8}$	Bias Binder, for $\frac{7}{8}$ inch binding.....	17
23322 J-1	Bias Binder, for 1 inch binding.....	17
23322 J-1 $\frac{1}{4}$	Bias Binder, for 1 $\frac{1}{4}$ inch binding.....	17
	Binder Screws No. 25 CC.	
23322 L	Binder Support, for Style 15900 D.....	17
	Binder Support Screws No. 90.	
23322 M	Binder Adjusting Plate.....	15
23322 N- $\frac{3}{4}$	Bias Binder, for Styles 13200 A, 15800 A, 15800 B, using $\frac{3}{4}$ inch width of binding.....	17
23322 N- $\frac{7}{8}$	Bias Binder, for $\frac{7}{8}$ inch binding.....	17
23322 N-1	Bias Binder, for 1 inch binding.....	17

∠ See page 25

LIST OF PARTS

Symbol to Order by	The figures in the last column refer only to the plates illustrating the parts, and are not to be used in ordering. Refer to pink insert for prices.	Plate No.
23322 N-1 $\frac{1}{8}$	Bias Binder, for 1 $\frac{1}{8}$ inch binding..... Binder Screws No. 87 U.	17
23322 P	Binder Swinging Arm Support Holder.....	17
23322 S	Binder Swinging Arm Support Holder Screws No. 25 CC Binder Swinging Arm Assembly, for Styles 13200 A, 15800 A, 15800 B; one each Nos. 86, 531, 12934 A, 12957 E, 23322 B and 23322 C.....	17
23377	Rick Rack and Hemming Attachment, for Style 15900 E..	17
23377 A	Rick Rack Guide, right.....	—
23377 B	Rick Rack Guide, left.....	—
23377 C	Rick Rack Guide Screws No. 22561. Hemmer, for No. 23377.....	—
29130 C	Hemmer Screws No. 22561.	—
29130 E	Needle Lever Eccentric and Balance Weight Assembly, for Styles 13200 A, 15800 A, 15800 B, 15800 E, 15800 G; one each Nos. 15434 and 15430 M lapped together.....	22
29131 B	Needle Lever Eccentric and Balance Weight Assembly, for Style 15800 D; one each Nos. 15834 and 15430 M lapped together.....	—
29132 C	Needle Lever Connection Upper Bearing Assembly, one each Nos. 1230 A and 15432 lapped together, 1230 B, 1230 D and 22586 A.....	22
29132 D	Knife Eccentric Assembly, for Style 15800 D; one each Nos. 15878 D, 15879 A, and 15879 E, lapped together..	—
29143	Knife Eccentric Assembly, for Styles 15800 E, 15800 G; one each Nos. 15878 E, 15879 A, and 15879 E, lapped together.....	—
29144	Knife Eccentric Assembly, for Styles 13200 A, 15800 A, 15800 B; one each Nos. 15878, 15879 and 15879 E, lap- ped together.....	—
29144 B	Looper Eccentric Assembly, for Styles in Class 15800 and 15900; one each Nos. 15814, 11354 and 15865 lapped together.....	—
29325 D	Looper Eccentric Assembly, for styles in Class 13200; one each Nos. 13214, 11354 and 15865 lapped together.....	—
29335	Needle Lever Assembly, for Style 15800 D; one each Nos. 15815 D and 1275 A, lapped together.....	—
29335 A	Needle Lever Assembly, for Styles 15800 A, 15800 B, 15800 E, 15800 G; one each Nos. 15815 and 1275 A lapped together.....	—
29402	Needle Lever Assembly, for styles in Classes 13200, 15900; one each Nos. 15915 and 1275 A lapped together.....	—
	Lifter Treadle Assembly; one each Nos. 422, 423, 424, 22813.....	28

LIST OF PARTS

Symbol to Order by	The figures in the last column refer only to the plates illustrating the parts, and are not to be used in ordering. Refer to pink insert for prices.	Plate No.
30036	Cloth Plate Extension Pivot Screw, hardened, for styles in Class 15900; also for Styles 15800 D, 15800 E, 15800 G	7
35582 B	Tension Thread Guide, sheet metal, for styles in Class 13200.....	10
41064 B	Looper Rock Shaft.....	20
41071 G	Take-up Thread Eyelet Holder Stop Screw Nut.....	8

